

Quicke

REDSKABER PRISLISTE JULI 2022

1. JULI 2022

Alo Danmark AS

Jegstrupvej 2A

7800 Skive

Tlf. 96 14 80 80

www.quicke.dk

Member of

**OPDATERT:
APRIL 2024**



INDHOLDSFORTEGNELSE

Generelle vilkår og fragtbetingelser	3
Team Alo Danmark	4
Prisgrupper på krogtyper	5
Næste generation skovle	6 - 7
Konverteringstabel skovle	8
Skovl Type S: Soil/jord skovl	9
Skovl Type G: General/universal skovl	10 - 11
Skovl Type V: Volume skovl	13
Tilbehør til skovle	14
Compakt og Utility skovle	16
Special skovle	17 - 18
Ensilage redskaber	19 - 25
Gødningsgrebe	26
Halmredskaber	27 - 32
Løfte redskaber	33 - 35
Stengreb	36
Frontvægte og kontravægte	37
Påboltelige krog sæt	38 - 39
Varenummer krog sæt	40 - 42
Krogguide	43 - 53

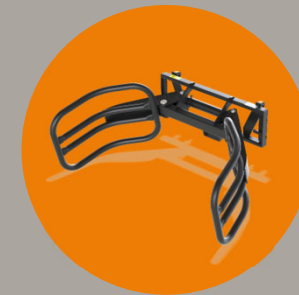
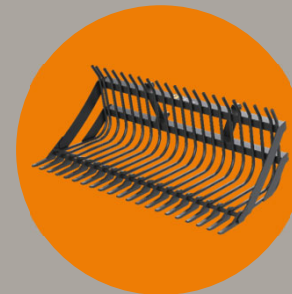
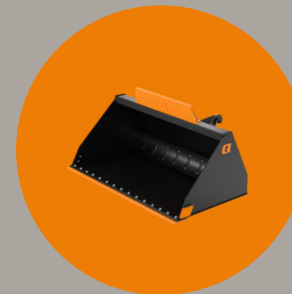

Priser:

Alle priser er angivet i danske kroner (DKK), eksklusiv moms og fragt.

Leveringsvilkår

Ex Works i henhold til Incoterms 2010

Garantiperiode

12 måneder

Retur

Returnering af varer, må kun ske efter forudgående aftale med ALO Danmark.

Varerne skal returneres i hel og ubeskadiget stand

Kreditering af returnerede varer vil ske med et fradrag på 10% af fakturabeløbet.

Reklamation/Ankomstkontrol

Eventuel reklamation i forbindelse med fejl/mangler, ved leverancer, skal ske senest 3 dage efter levering.

Kontroller derfor altid varen umiddelbart efter levering.

Rentetilskrivning

Ved for sen betaling påregnes rente i forhold til gældende lovgivning.

Fragtbetingelser for frontlæssere samt redskaber

Køb under DKK 10.000 brutto Ab fabrik Skive

Køb over DKK 10.000 brutto Franco til brofaste øer

Levering til ikke-brofaste øer efter nærmere aftale

Monteringsomkostninger redskab:

Montering af krogset: 150 DKK netto

Montering af krogset og tilbehør: 450 DKK netto

Vore generelle salgs- og leveringsbetingelser kan du finde på vores hjemmeside www.quicke.dk Klik på KONTAKT - FORHANDLEROMRÅDE - DOKUMENTER

Alo Danmark / Ålö AB tager forbehold for eventuelle trykfejl, produktændringer, prisjusteringer og andre ændringer i denne prisliste.

ERIK THYKIÆR THOMSEN
SALG - ORDRE



Tlf: 9614 8080
Mobil: 2014 8702
E-mail: erik.thomsen@alo.se

MICHAEL DAMGAARD
SALG - SERVICE



Tlf: 9614 8080
E-mail: michael.damgaard@alo.se

OLE SERUP JENSEN
ADMINISTRATION – EKSPEDITION OG SALG



Tlf: 9614 8080
E-mail: ole.serup.jensen@alo.se

ET STORT ANTAL KROGE FOR MANGE FORSKELLIGE MASKINER

Quicke

Mange Quicke-redskaber kan leveres med svejste Euro-kroge og SMS-kroge. Foruden svejste kroge så kan vi til de fleste redskaber, som i prislisten er markeret med BoH, leverere dem med påboltelig kroge.

Redskaber med påboltelige kroge har en basispris. Dertil tillægges prisen for krogsæt, eventuelle slangesæt og tilbehør til basispris.

Totalt så har vi 7 forskellige krogsystemer og 4 forskellige prisgrupper.

KROGSYSTEM OG PRISGRUPPE

KROGSYSTEM		PRISGRUPPE	
		A	B
BoH 40x80	40 x 80	1 700 kr	3 000 kr
BoH 60x80	60 x 80	1 700 kr	3 000 kr
BoH 80x80	80 x 80	1 700 kr	3 000 kr
BoH Rail S/L	Rail S/L	3 000 kr	
BoH M24	M24	4 200 kr	
BoH 80x80XL	80 x 80 XL	4 200 kr	
BoH M16 S/L	M16 S M16 L	1 700 kr 2 600 kr	

Bagerst i denne prisliste findes vores krogguide. Der fremgår alle kroge og hvilket BoH-krogsystem vi tilbyder krogen i. I vores quicke-konfigurator kan redskabet også konfigureres med krogtyper. Den findes på <https://alo.force.com>

Varenummer på krogsæt
finder du på side 39



FRONTLÆSSER



HJULLÆSSERE



TELESKOPLÆSSERE



MINDRE HJULLÆSSERE



SKIDSTEERS



KOMPAKTLÆSSER



KONTRAVÆGTE



- ❗ Quicke tilbyder både svejste og påboltede krogtyper(BoH).
- ❗ Quicke tilbyder en bred vifte af krogtyper, tilpasset en bred vifte af læsemaskiner. Men også specielle krogtyper som er tilpasset læsemaskiner med f.eks. Z-kinematik, store hjul eller begrænset tilbagetip.
- ❗ Quicke anvender moderne teknik for at sikre at din skovl får en perfekt pasform og funktion på din læsemaskine.
- ❗ Quicke tilbyder en enkel montering af påboltelig skærstål. Boltene monteres alle ovenfra og ned. Da skærstålene har gevind i hullerne skal der ikke anvendes møtrikker.
- ❗ Quicke tilbyder påboltelig spildkant som er let at montere i de forborede huller. Redskabsrammen beskyttes dermed imod overflødig materiale.
- ❗ Quicke tilbyder plastik væg beskyttere for at undgå skader på mur eller silovæg. Skovlene er forberedt med huller til montering af disse beskyttere så de er hurtige og lette at påbolte.

- 1 Konisk design som sikrer hurtig og komplet tømning af skovlen.
- 2 Kraftig dobbelt konstruktion giver skovlene ekstrem stor vridningsstyrke, samtidig med at det skjuler påboltningssystemet. Dette betyder, at der ingen forstærkninger er inde i skovlen, som er med til at give en lettere ifyldning.
- 3 Kraftige skær i 500 Brinell og tykke velplacerede slid-skiner under skovlen giver skovlen en længere levetid og størst mulig produktivitet.
- 4 Store kraftige saddeplader på skovlens bagside sikrer at kraften fra læsemaskinen bliver lagt ned i skovlbund og på skærstål.
- 5 Alle vores redskaber er pulverlakeret hvilket giver en hård og slidstærk ydre.



- Uanset om det er en minilæsser eller en større læsemaskine, kan du være sikker på, at vores modul opbyggede skovlserie altid giver dig den perfekte tilpasning og funktion af din maskine. . Med mere end 60 forskellige påboltelige krogsæt tilbyder Quicke en bred vifte af muligheder.
- Vores løfte: Quicke passer altid!

Størrelse og specifikationer

TYP S	TYP G	TYP V
JORD	UNIVERSAL	VOLUME
		
SXL+	GXL+	VXL+
SL+	GL+	VL+
SM+	GM+	VL
SM	GM	VM
–	GS+	–
–	GS	VS

Skovtype

Modeller med **+** findes tillgængelig med påboltelig krogtyper og påboltelig tilbehør.



KONVERTERINGSTABEL FOR GAMMEL/NY SKOVL SERIER

Quicke

S

Gammel skovlserie		Ny skovlserie	
Serie	Model	Jordskovl Type S	Model
HDXL	270, 290	SXL+	275, 295
HDXL	220, 240, 260	SL+	220, 240, 265
HD	185, 210, 240, 260	SM+	160, 180, 200, 220, 240,
HT	135, 160, 185, 210	SM+	260
S	185, 210	SM	185, 210

UNIVERSALSKOVL TYPE G (GENERAL)

G

Gammel skovlserie		Ny skovlserie	
Serie	Model	Universalskovl Type G	Model
HDX stor	1921, 2023, 2124	GXL+	200, 220, 240, 260
HDX mellem	1421, 1523, 1624	GL+	180, 200, 220, 240, 260
HDX lille	1021, 1123, 1224	GM+	180, 200, 220, 240
H	135, 160, 185, 210, 240	GM	140, 165, 185, 215, 245
<i>Ny model</i>		GS+	90, 110, 120, 140, 160
L	130, 180	GS	135, 185

VOLUMESKOVL TYPE V (VOLUME)

V

Gammel skovlserie		Ny skovlserie	
Serie	Model	Volumeskovl Type V	Model
XV	240, 260, 280, 300	VXL+	245, 265, 285, 305
HDV	<i>Stærkere og med mere volume end HDV</i>	VL+	180, 200, 220, 240, 260
HDV	240, 260	VL	245, 265
HV	200, 220	VL	205, 225
HXV	180, 200, 220, 240, 260	VM	185, 205, 225, 245, 265
LV	200, 220	VS	200, 220

Forklaring, skovlbenævnelse

XL	Skovle til medium størrelse hjullæssere og teleskoplæssere.
L	Skovle til kompakt hjullæssere, teleskoplæssere og større frontlæssere.
M	Skovle til kompakt hjullæssere, teleskoplæssere og frontlæssere.
S	Skovle til mini læsemaskiner og frontlæssere.

TYPE S JORDSKOVL

Quicke

SXL+ SKOVL			275	295
	Bredde	cm	271	291
	Dybde	cm	129	129
	Højde	cm	133	133
	Volume, med top	m ³	2.50	2.70
	Volume, strøget mål	m ³	2.00	2.10
	Vægt	kg	1158	1216
PRIS: Uden kroge			45 900	50 700
Krogsæt			4 200	
Skærstål 500 HB			6 300	7 000
Påboltelig tandkit			5 100	5 700
Spildkant			1 500	1 500

Skæret er forberedt med huller for ekstra skærstål

Montering af krogsæt:
150 kr netto

BoH
M24

SM+ SKOVL			160	180	200	220	240	260
	Bredde	cm	158	178	198	218	238	258
	Dybde	cm	89	89	89	89	89	89
	Højde	cm	75,5	75,5	75,5	75,5	75,5	75,5
	Volume, med top	m ³	0.76	0.86	1.00	1.06	1.16	1.26
	Volume, strøget mål	m ³	0.60	0.68	0.76	0.84	0.90	1.00
	Vægt	kg	231	251	269	296	367	390
PRIS: Påsvejste kroge			11 200	11 500	14 000	14 500	15 200	19 200
PRIS: Uden kroge			10 100	10 400	12 900	13 400	14 100	18 100
Krogsæt			2 600					
Skærstål 500 HB			3 700	4 000	4 300	4 700	5 100	5 300
Påboltelig tandkit			2 500	2 500	2 900	2 900	3 200	3 800
Spildkant			1 400	1 400	1 400	1 400	1 400	1 400

Skæret er forberedt med huller for ekstra skærstål

Montering af krogsæt:
150 kr netto

Euro
SMS

BoH
M16 L

SL+ SKOVL			220	240	265
	Bredde	cm	217	237	262
	Dybde	cm	105	105	120
	Højde	cm	112	112	123
	Volume, med top	m ³	1.30	1.40	2.00
	Volume, strøget mål	m ³	1.00	1.10	1.60
	Vægt	kg	634	669	789
PRIS: Uden kroge			23 700	27 900	30 100
Krogsæt			4 200		
Skærstål 500 HB			5 300	5 800	6 100
Påboltelig tandkit			3 300	3 900	4 400
Spildkant			1 500	1 500	1 500

Skæret er forberedt med huller for ekstra skærstål

Montering af krogsæt:
150 kr netto

BoH
M24

Varenummer på krogsæt
finder du på side 40

TYPE G UNIVERSAL SKOVL

Quicke

GXL+ SKOVL			200	220	240	260
	Bredde	cm	198	218	238	258
	Dybde	cm	136.5	136.5	136.5	136.5
	Højde	cm	101.5	101.5	101.5	101.5
	Volume, med top	m ³	1.75	1.94	2.11	2.31
	Volume, strøget mål	m ³	1.40	1.55	1.69	1.85
	Vægt	kg	497	529	588	619
	PRIS: Uden kroge		19 100	19 500	20 100	20 700
Krogsæt		4 200				
Skærstål 500 HB		4 300	4 700	5 100	5 300	
Skærstål plast		6 100	6 900	7 300	7 900	
Isskær		4 800	5 200	5 700	5 900	
Spildkant		1 500	1 500	1 500	1 500	

Skæret er forberedt med huller for ekstra skærstål

Montering af krogsæt: 150 kr netto

BoH
M24

GM+ SKOVL			180	200	220	240
	Bredde	cm	178	198	218	238
	Dybde	cm	104.5	104.5	104.5	104.5
	Højde	cm	78	78	78	78
	Volume, med top	m ³	1.02	1.14	1.27	1.40
	Volume, strøget mål	m ³	0.81	0.90	0.99	1.09
	Vægt	kg	300	324	357	380
	PRIS: Uden kroge		13 000	13 800	14 700	15 400
Krogsæt		2 600				
Skærstål 500 HB		4 000	4 300	4 700	5 100	
Skærstål plast		5 800	6 100	6 900	7 300	
Isskær		4 600	4 800	5 200	5 700	
Spildkant		1 400	1 400	1 400	1 400	

Skæret er forberedt med huller for ekstra skærstål

Montering af krogsæt: 150 kr netto

BoH
M16 L

GL+ SKOVL			180	200	220	240	260
	Bredde	cm	178	198	218	238	258
	Dybde	cm	124.5	124.5	124.5	124.5	124.5
	Højde	cm	90.5	90.5	90.5	90.5	90.5
	Volume, med top	m ³	1.23	1.40	1.55	1.71	1.90
	Volume, strøget mål	m ³	1.00	1.12	1.25	1.37	1.50
	Vægt	kg	420	448	473	529	558
	PRIS: Uden kroge		14 000	15 200	16 100	17 200	18 500
Krogsæt		4 200					
Skærstål 500 HB		4 000	4 300	4 700	5 100	5 300	
Skærstål plast		5 800	6 100	6 900	7 300	7 900	
Isskær		4 600	4 800	5 200	5 700	5 900	
Spildkant		1 500	1 500	1 500	1 500	1 500	

Skæret er forberedt med huller for ekstra skærstål

Montering af krogsæt: 150 kr netto

BoH
M24

GM SKOVL			140	165	190	215	245
	Bredde	cm	138	163	188	212	243
	Dybde	cm	81.5	81.5	81.5	81.5	81.5
	Højde	cm	71.5	71.5	71.5	71.5	71.5
	Volume, med top	m ³	0.54	0.65	0.72	0.82	0.95
	Volume, strøget mål	m ³	0.45	0.54	0.60	0.69	0.79
	Vægt	kg	146	165	205	251	293
	PRIS: Påsvejste kroge		6 500	7 600	9 300	12 000	13 900

Euro SMS

GM skovl erstatter H skovl

Varenummer på krogsæt finder du på side 40

TYPE G UNIVERSAL SKOVL

Quicke

GS+ SKOVL			90	100	120	140	160
	Bredde	cm	88	98	118	138	158
	Dybde	cm	82.5	82.5	82.5	82.5	82.5
	Højde	cm	64.5	64.5	64.5	64.5	64.5
	Volume, med top	m ³	0.32	0.36	0.44	0.53	0.61
	Volume, strøget mål	m ³	0.26	0.29	0.36	0.42	0.48
	Vægt	kg	108	116	134.5	180.5	197
PRIS: Uden kroge			5 400	6 000	6 900	8 000	8 600
Krogsæt			1 700			2 600	
<div style="border: 1px solid black; padding: 2px; margin-bottom: 5px;">Skæret er forberedt med huller for ekstra skærstål</div> <div style="border: 1px solid black; padding: 2px;">Montering af krogsæt: 150 kr netto</div> <div style="border: 1px solid black; padding: 2px; margin-top: 5px;">BoH M16 S/L</div>	Skærstål 500 HB		1 900	2 100	2 400	2 700	3 000
	Skærstål plast		2 900	3 300	4 000	4 600	4 900
	Isskær		2 100	2 400	2 600	3 000	3 300
	Spildkant		N/A	N/A	N/A	2 000	2 000

M16S-krogkit anbefales på størrelse 90, 100 og 120
M16L-krogkit anbefales på størrelse 140 og 160



GS SKOVL			135	185
	Bredde	cm	137	187
	Dybde	cm	78.4	78.4
	Højde	cm	79	79
	Volume, med top	m ³	0.51	0.71
	Volume, strøget mål	m ³	0.40	0.60
	Vægt	kg	126	166
PRIS: Påsvejste kroge			5 400	8 500

Euro
SMS

GS skovl erstatter L skovl



Varenummer på krogsæt
finder du på side 40



MPU 160 EURO



XH 220



SM+ 180



GS+ 120

TYPE V VOLUME SKOVL

Quicke

VXL+ SKOVL			245	265	285	305
	Bredde	cm	244	261	283	302
	Dybde	cm	156	156	171	171
	Højde	cm	124	124	132	147
	Volume, med top	m ³	3.00	3.20	4.00	5.00
	Volume, strøget mål	m ³	2.40	2.60	3.20	4.00
	Vægt	kg	727	761	1120	1313
	PRIS: Uden kroge		23 100	27 200	35 700	51 500
Krogsæt			4 200			
	Skærstål 500 HB		6 100	6 300	6 900	7 200
	Skærstål plast		8 900	9 400	10 100	10 500
	Isskær		6 500	7 000	7 200	7 500
	Gavlbeskytter		2 000	2 000	2 000	2 000
	Spildkant		1 500	1 500	1 500	1 500
	Coverplade		900	900	900	900

Skæret er forberedt med huller for ekstra skærstål

BoH
M24

VL+ SKOVL			180	200	220	240	260
	Bredde	cm	178	198	218	238	258
	Dybde	cm	107.5	107.5	107.5	124.5	124.5
	Højde	cm	96	96	96	106	106
	Volume, med top	m ³	1.30	1.46	1.62	2.22	2.42
	Volume, strøget mål	m ³	1.07	1.19	1.32	1.80	1.95
	Vægt	kg	403	430	457	558	589
	PRIS: Påsvejste kroge		15 700	16 900	18 000	19 100	21 600
PRIS: Uden kroge		11 900	13 100	14 200	15 300	17 300	
Krogsæt			4 200				
	Skærstål 500 HB		4 000	4 300	4 700	5 100	5 300
	Skærstål plast		5 800	6 100	6 900	7 300	7 900
	Isskær		4 600	4 800	5 200	5 700	5 900
	Gavlbeskytter		1 100	1 100	1 100	1 100	1 100
	Spildkant		1 500	1 500	1 500	1 500	1 500
	Coverplade		700	800	800	900	900

Skæret er forberedt med huller for ekstra skærstål

Euro
SMS

BoH
M24

VL SKOVL			205	225	245	265
	Bredde	cm	204	224	245	265
	Dybde	cm	104	104	109.5	109.5
	Højde	cm	83	83	98	98
	Volume, med top	m ³	1.16	1.28	1.70	1.85
	Volume, strøget mål	m ³	0.97	1.06	1.42	1.54
	Vægt	kg	292	317	466	499
	PRIS: Påsvejste kroge		11 500	12 700	15 400	17 000

Euro
SMS

VL skovl erstatter HV og HDV skovl

VM SKOVL			185	205	225	245	265
	Bredde	cm	184	204	224	245	265
	Dybde	cm	104.5	104.5	104.5	109.5	109.5
	Højde	cm	98	98	98	98	98
	Volume, med top	m ³	1.45	1.60	1.70	2.00	2.20
	Volume, strøget mål	m ³	0.95	1.10	1.20	1.45	1.60
	Vægt	kg	316	341	366	417	443
	PRIS: Påsvejste kroge		14 000	15 200	15 600	18 000	19 600

Euro

VM skovl erstatter HXV skovl

VS SKOVL			200	220
	Bredde	cm	202	222
	Dybde	cm	101.5	101.5
	Højde	cm	83	83
	Volume, med top	m ³	1.13	1.25
	Volume, strøget mål	m ³	0.95	1.04
	Vægt	kg	219	235
	PRIS: Påsvejste kroge		8 000	8 800

Euro
SMS

VS skovl erstatter LV skovl

VS+ SKOVL			90	100	120	140	160
	Bredde	cm	88	98	118	138	158
	Dybde	cm	97	97	97	97	97
	Højde	cm	75	75	75	75	75
	Volume, med top	m ³	0.43	0.47	0.59	0.70	0.81
	Volume, strøget mål	m ³	0.35	0.39	0.47	0.56	0.64
	Vægt	kg	118	131	157	185	211
	PRIS: Uden kroge		6 200	6 600	7 400	8 300	9 800
Krogsæt			1 700		2 600		
	Skærstål 500 HB		1 900	2 100	2 400	2 700	3 000
	Skærstål plast		2 900	3 300	4 000	4 600	4 900
	Isskær		2 100	2 400	2 600	3 000	3 300
	Spildkant		N/A	750	750	750	750

NEW

BoH
M16 S/L

Fra størrelse 120 er Euro-krog mulig.
M16L-krogkit anbefales på størrelse 140 og 160

Varenummer på krogsæt
finder du på side 40

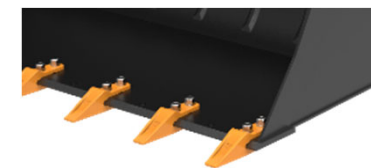
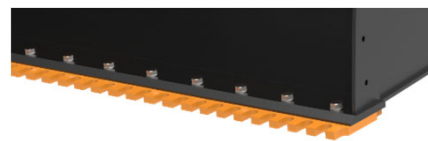

Skærstål 500 HB		
GS+		
Skærstål 500 HB 90	11255524Q	1 900
Skærstål 500 HB 100	11255525Q	2 100
Skærstål 500 HB 120	11255527Q	2 400
Skærstål 500 HB 140	11255528Q	2 700
Skærstål 500 HB 160	11255529Q	3 000
SM+ / GM+ / GL+ / GXL+ / VL+		
Skærstål 500 HB 160	11255535Q	3 700
Skærstål 500 HB 180	11255493Q	4 000
Skærstål 500 HB 200	11255494Q	4 300
Skærstål 500 HB 220	11255495Q	4 700
Skærstål 500 HB 240	11255496Q	5 100
Skærstål 500 HB 260	11255497Q	5 300
VXL+		
Skærstål 500 HB 245	11255659Q	6 100
Skærstål 500 HB 265	11255660Q	6 300
Skærstål 500 HB 285	11255661Q	6 900
Skærstål 500 HB 305	11255662Q	7 200
SL+ / SXL+		
Skærstål 500 HB 220	11255782Q	5 300
Skærstål 500 HB 240	11255783Q	5 800
Skærstål 500 HB 265	11255784Q	6 100
Skærstål 500 HB 275	11255785Q	6 300
Skærstål 500 HB 295	11255786Q	7 000

Skærstål PLAST		
GS+		
Skærstål plast 90	11255547Q	2 900
Skærstål plast 100	11255546Q	3 300
Skærstål plast 120	11255545Q	4 000
Skærstål plast 140	11255544Q	4 600
Skærstål plast 160	11255543Q	4 900
SM+ / GM+ / GL+ / GXL+ / VL+		
Skærstål plast 160	11255537Q	5 200
Skærstål plast 180	11255505Q	5 800
Skærstål plast 200	11255506Q	6 100
Skærstål plast 220	11255507Q	6 900
Skærstål plast 240	11255508Q	7 300
Skærstål plast 260	11255509Q	7 900
VXL+		
Skærstål plast 245	11255665Q	8 900
Skærstål plast 265	11255667Q	9 400
Skærstål plast 285	11255669Q	10 100
Skærstål plast 305	11255671Q	10 500

Isskær		
GS+		
Isskær 90	11255538Q	2 100
Isskær 100	11255539Q	2 400
Isskær 120	11255540Q	2 600
Isskær 140	11255541Q	3 000
Isskær 160	11255542Q	3 200
SM+ / GM+ / GL+ / GXL+ / VL+		
Isskær 160	11255536Q	4 200
Isskær 180	11255499Q	4 600
Isskær 200	11255501Q	4 800
Isskær 220	11255502Q	5 200
Isskær 240	11255503Q	5 700
Isskær 260	11255504Q	5 900
VXL+		
Isskær 245	11255664Q	6 500
Isskær 265	11255666Q	7 000
Isskær 285	11255668Q	7 200
Isskær 305	11255670Q	7 500

Påboltelige tænder		
SM+ / SL+ / SXL+		
Tænder SM+ 160-180 6 st 18 mm	11255726Q	2 500
Tænder SM+ 200-220 7 st 18 mm	11255727Q	2 900
Tænder SM+ 240 8 st 18 mm	11255728Q	3 200
Tænder SM+ 260 9 st 18 mm	11255729Q	3 800
Tænder SL+ 220 7 st 20 mm	11255414Q	3 300
Tænder SL+ 240 8 st 20 mm	11255417Q	3 900
Tænder SL+ 265 9 st 20 mm	11255418Q	4 400
Tænder SXL+ 275 9 st 25 mm	11255419Q	5 100
Tænder SXL+ 295 10 st 25 mm	11255420Q	5 700



Gavlbeskytter		
Gavlbeskytter GXL+/GL+/GM+/GS+	11255516Q	1 100
Gavlbeskytter VL+	11255517Q	1 100
Gavlbeskytter VXL+ 245-265	11255643Q	2 000
Gavlbeskytter VXL+ 285-305	11255730Q	2 000

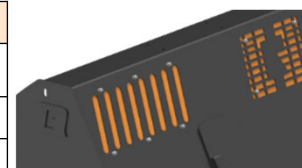

Coverplade		
VL+ / VXL+		
Coverplade VL+ 180	11255606Q	700
Coverplade VL+ 200/220	11255608Q	800
Coverplade VL+/VXL+ 240-305	11255609Q	900



SPILDKANT

Sikre at der ikke spilles hen over ryggen på skovlen og ned i redskabsramme.

NEW

SPILDKANT S

S



GS+, VS+ Skovle			
A. Bredde	mm		900
B. Dybde	mm		241
C. Højde	mm		139
11256175Q	PRIS:		750

SPILDKANT M

M



GM+, SM+. Gødningsgreb, Multibenne, Silograb XL			
A. Bredde	mm		1300
B. Dybde	mm		241
C. Højde	mm		139
11256105Q	PRIS:		1 400

SPILDKANT L OG XL

L & XL

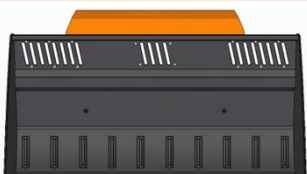

GL+, GXL+, VL+, VXL+,SL+, SXL+ Skovle			
A. Bredde	mm		1550
B. Dybde	mm		296
C. Højde	mm		212
11256106Q	PRIS:		1 500

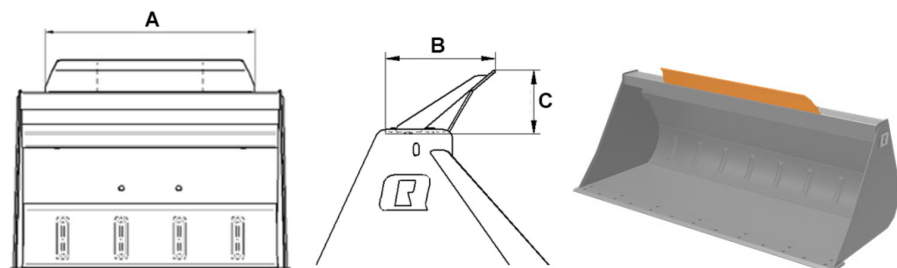

TRANSPORTSIKRING

Transportsikring til redskaber som f.eks. Stengreb eller Storballegrab. Øger sikkerheden ved kørsel på offentlig veje.

Der findes 2 kit så alle bredder af redskab dækkes.

NEW

TRANSPORTSIKRING 120-220 OG 220-295

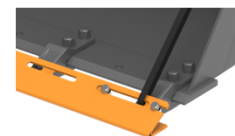

120 - 220		
Justerbar bredde	cm	120-220
Vægt	kg	12
11256300Q	PRIS:	450
220 - 295		
Justebar bredde	cm	220-295
Vægt	kg	17
11256329Q	PRIS:	550

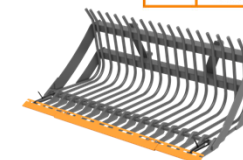
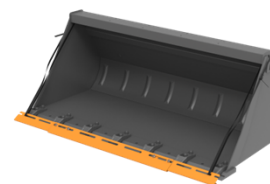

SKÆRSTÅL PROP

NEW

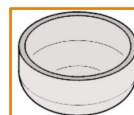

Beskrivelse	Dia mm	Antal	Artikelnr.	Pris
Skærstål prop S+	19.4	15	11256494Q	120
Skærstål prop M+ - XL+	23.4	18	11256497Q	150
Skærstål prop M+ - XL+		30	11256498Q	200

Til kunder som håndtere løst materiale med skovle, hvor der er hul i skærstålet, beregnet for montering af et ekstra skærstål. Propperne monteret i hullerne for at undgå spild.

KOMPAKT OG UTILITY SKOVL

Quicke

CS OG CM SKOVL			120 CS	135 CS	150 CM
	Bredde	cm	120	136	150
	Dybde	cm	60	60	60
	Højde	cm	50	50	55
	Volume, med top	m ³	0.20	0.23	0.29
	Volume, strøget mål	m ³	0.15	0.17	0.22
	Vægt	kg	69	76	91
	PRIS: Påsvejste kroge			3 800	4 300

Euro

4-i-en SKOVL UTILITY			160 MPU	185 MPU	210 MPU
	Bredde	cm	162.1	187.1	212.1
	Dybde	cm	54	54	54
	Højde	cm	60	60	60
	Volume, med top	m ³	0.40	0.47	0.53
	Volume, strøget mål	m ³	0.32	0.37	0.42
	Vægt	kg	264	291	318
	PRIS: Påsvejste kroge			24 800	27 800

Euro

CL/U SKOVL			130 CL	150 CL	170 CL	180 U	210 U
	Bredde	cm	132	152	172	185	215
	Dybde	cm	66.5	66.5	66.5	74.6	74.6
	Højde	cm	59	59	59	61	61
	Volume, med top	m ³	0.34	0.39	0.44	0.57	0.68
	Volume, strøget mål	m ³	0.28	0.32	0.36	0.47	0.55
	Vægt	kg	99	109	120	173	196
	PRIS: Påsvejste kroge			5 100	5 300	5 600	N/A

Euro

MULTIGRAB C & CS			CS 120	C 120	C 140	C170	
	Bredde	cm	124	124	139	172	
	Dybde	cm	51.6	59.8	59.8	59.8	
	Højde	cm	64	74	74	74	
	Volume	m ³	0.22	0.3	0.34	0.42	
	Vægt	kg	90	133	141	161	
	PRIS: Påsvejste kroge			9 700	11 500	12 200	13 000
	Gavlforøgere			300	400		
Gribeskinne, savtakket			400		500		

Euro
Skid
steer

NEW

4-I-EN SKOVL KOMPAKT			120 MPC	140 MPC	170 MPC	180 MPC
	Bredde	cm	122	137.1	167.1	182.1
	Dybde	cm	40.8	40.8	40.8	40.8
	Højde	cm	44	44	44	44
	Volume, med top	m ³	0.19	0.21	0.25	0.28
	Volume, strøget mål	m ³	0.14	0.16	0.19	0.21
	Vægt	kg	132	155	177	187
	PRIS: Påsvejste kroge			11 800	13 200	14 200

Pin-on
(120)
Euro
(140-
180)

Tilbehør:

Gavlforøgere



Gribeskinne, savtakket

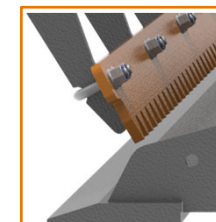

Gavlforøgere + Greb stål



Varenummer på krog sæt
finder du på side 40

SPECIALSKOVL

Quicke

4-1-EN SKOVL			160 MP	185 MP	210 MP	160 MPT	185 MPT	210 MPT
	Bredde	cm	161.6	186.6	211.6	161.6	186.6	211.6
	Dybde	cm	67	67	67	67	67	67
	Højde	cm	67.5	67.5	67.5	67.5	67.5	67.5
	Volume, med top	m ³	0.48	0.56	0.66	0.48	0.56	0.66
	Volume, strøget mål	m ³	0.38	0.44	0.50	0.38	0.44	0.50
	Vægt	kg	267	401	434	373	407	441
PRIS: Påsvejste kroge			34 600	42 600	46 200	37 200	44 800	48 600

Euro

MP er uden tænder på skæret
MPT er med tænder på skæret

SNESKOVL SC M+			230 M+
	Bredde, skovl	cm	230
	Bredde med udslået vinger	cm	392
	Dybde	cm	109
	Højde	cm	98
	Volume, med top	m ³	1.41
	Volume, strøget mål	m ³	1.14
Vægt	Kg	660	
PRIS: Uden kroge			48 300
Krogsæt			2 600
Snepløvvinge, venstre eller højre			9 900
Skærstål 500 HB			4 700
Isskær			7 600
El-ventilsæt for Quicke frontlæssere			4 000
El-ventilsæt universal			2 000



Over 210 bar
Trykgrænserventil
nødvendig

BoH
M16 L

Tilbehør:
Snepløvvinger

Montering af
krogsæt: 150 kr netto



HØJTIPPENDE SKOVL			160 XH	180 XH	200 XH	220 XH	240 XH	260 XH
	Bredde	cm	160	181	201	221	241	261
	Dybde	cm	117.3	117.3	117.3	117.3	117.3	117.3
	Højde	cm	104.5	104.5	104.5	104.5	104.5	104.5
	Volume, med top	m ³	1.40	1.51	1.75	1.96	2.18	2.40
	Volume, strøget mål	m ³	1.20	1.37	1.52	1.64	1.86	2.08
	Vægt	kg	481	514	566	600	635	669
PRIS: Påsvejste kroge**			N/A	N/A	34 600	38 200	40 500	45 000
PRIS: Uden kroge			30 000	31 200	32 100	35 700	38 000	42 500
Krogsæt			A = 1 700 B = 3 000					
Slanger			700					

Euro
SMS



Over 210 bar
Trukgrænserventil
nødvendig

BoH
40x80

** Version med påsvejste kroge leveres komplet med slanger som passer på Quicke frontlæssere.

Montering af
krogsæt: 150 kr netto

PRÆCISIONSSKOVL			200 PS	200 PC	250 PS	250 PC
	Bredde	cm	114.5	54.5	115	86.5
	Dybde	cm	198.5	198.5	249	249
	Højde	cm	61.5	61.5	76	76
	Volume, med top	m ³	0.93	0.87	1.69	1.54
	Volume, strøget mål	m ³	0.87	0.71	1.55	1.40
	Vægt	kg	302	271	577	566
PRIS: Påsvejste kroge			15 100	16 000	21 100	22 400

Euro
SMS
Store
BM
(250)

Varenummer på krogsæt
finder du på side 40

PLANERINGSSKOVL			180	200	220	240
	Bredde	cm	184	204	224	244
	Dybde	cm	109	109	109	109
	Højde	cm	48	48	48	48
	Volume, med top	m ³	0.62	0.70	0.78	0.86
	Volume, strøget mål	m ³	0.44	0.49	0.52	0.58
	Vægt	Kg	282	308	333	402
	Skærstål BxT	mm	150X20	150X20	150X20	200X20
	PRIS: Påsvejste kroge			14 100	15 200	16 000

Euro
SMS

PLANERINGSSKOVL S			100	120	140	160
	Bredde	cm	98	118	138	158
	Dybde	cm	83	83	83	83
	Højde	cm	40	40	40	40
	Volume, med top	m ³	0.22	0.28	0.33	0.39
	Volume, strøget mål	m ³	0.15	0.19	0.22	0.25
	Vægt	kg	110	125	160	177
	Skærstål BxT	mm	100X14	100X14	100X14	100X14
	PRIS: Påsvejste kroge			9 900	10 400	10 600
Overbygning			2 300	2 600	2 900	3 100

Euro *120-160
SMS
Avant
Kramer Kompact

PLANERINGSSKOVL XL			220 XL	240 XL	260 XL	280 XL	300 XL
	Bredde	cm	220.6	242.6	262.5	282.8	302.4
	Dybde	cm	118	118	137.5	137.5	152.5
	Højde	cm	54.5	54.5	54.5	54.5	54.5
	Volume, med top	m ³	1.05	1.15	1.56	1.69	1.97
	Volume, strøget mål	m ³	0.79	0.87	1.14	1.23	1.97
	Vægt	kg	646	683	900	945	1151
	Skærstål BxT	mm	200X20	200X20	200X25	200X25	250X30
	PRIS: Påsvejste kroge			25 900	27 200	31 600	33 000
Spildkant			2 200	2 200	2 200	2 200	2 200
Surringsøjler			300	300	300	300	300
Overbygning			5 600	5 700	6 400	6 600	7 400



Store
BM

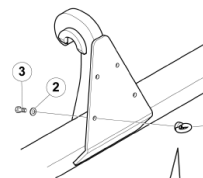
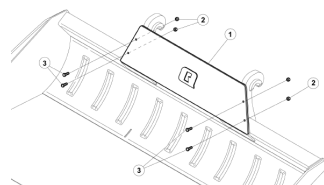

Tilbehør:
Overbygning

Tilbehør:
Overbygning
Spildkant
Surringsøjler



POWERGRAB M+			165 ¹	180	200	220	240 ³	260 ³	Åbning
	Bredd	cm	165	180	200	220	240	260	1620mm
	Dybde	cm	116	116	116	82	116	116	
	Volume	m ³	1.0	1.1	1.2	1.3	1.4	1.5	
	Vægt	kg	558	588	617	660	759	780	
PRIS: Påsvejste kroge			N/A	N/A	38 800	41 500	43 500	NA	
PRIS: Uden kroge			31 500	33 600	36 800	39 500	41 500	43 500	
Krogsæt			2 600						
Skærstål 500 HB			3 600	4 000	4 300	4 700	5 100	5 300	
Slangar frontlæssere			700						
Trykbegrænserventil			2 100						
Lastholdeventil			2 900						

¹PowerGrab 165 med EURO kroge passer ikke på Q-serie frontlæssere med EURO eller EURO/SMS redskabsramme.

²PowerGrab med påsvejste kroge er med hydraulikslanger som passer til Quicke frontlæssere.

Anvend M16L Euro 16⁹ til Quicke frontlæssere

BoH
M16 L

Unik mulighed for 2-delt overfald
PowerGrab M+ i bredde 240 og 260 fås også med 2-delt overfald. Det betyder at højre og venstre side af overfaldet kan bevæge sig uafhængigt af hinanden. Dette er en fordel ved udtagning af ensilage fra stak eller håndtering af anden løst materiale.



³Merpris for 2-delt overfald er 1.000 Kr.

NEW



Over 210 bar
Trykbegrænserventil
nødvendig



POWERGRAB L+			200	220	240	260
	Bredde	cm	200	220	240	260
	Dybde	cm	100	100	100	100
	Volume	m ³	1.60	1.75	1.95	2.10
	Max åbningshøjde	cm	199	199	199	199
	Skærstål (BxT)	mm	200X20	200X20	200X20	200X20
	Vægt	kg	917	957	1060	1097
PRIS: Uden kroge			44 000	47 000	50 000	53 000
Krogsæt			4 200			
Skærstål 500 HB			5 000	5 100	5 300	5 500
Slangar frontlæssere			700			
Trykbegrænserventil			2 100			

NEW

Montering af
krogsæt: 150 kr netto





Over 230 bar
Trykbegrænserventil
nødvendig

BoH
M24

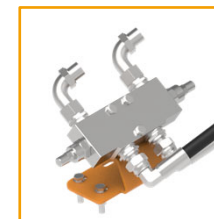
Lastholdeventil**

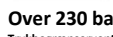

**Viktig. Lastholdeventilen indeholder ikke en trykbegrænsere.

POWERGRAB XL+			240	260	280	295
	Bredde	cm	240	260	280	295
	Dybde	cm	116	116	116	116
	Volume	m ³	2.45	2.65	2.85	3.0
	Max åbningshøjde	cm	213	213	213	213
	Skærstål (BxT)	mm	200X20	200X20	200X20	200X20
	Vægt	kg	1336	1380	1425	1458
PRIS: Uden kroge			64 100	68 600	75 400	77 300
Krogsæt			4 200			
Skærstål 500 HB			5 800	6 000	6 200	7 000
Trykbegrænserventil			2 100			

Montering af
krogsæt: 150 kr netto



Over 230 bar
Trykbegrænserventil
nødvendig

BoH
M24

Varenummer på krogsæt
finder du på side 40

SILOCUT M+

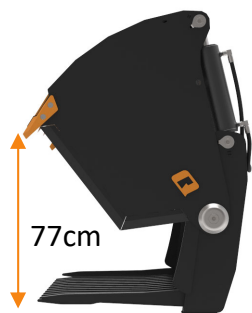

		125 F	150 F	175 F	200 F	225 F	150 P	175 P	200 P	225 P
Bredde	cm	125	150	175	200	225	150	175	200	225
Max tryk	bar	210	210	210	250	250	210	210	250	250
Max åbningshøjde	cm	77	77	77	77	77	77	77	77	77
Total højde	cm	95	95	95	95	95	95	95	95	95
Dybde	cm	67	67	67	67	67	67	67	67	67
Antal tænder		8	10	12	14	16	10	12	14	16
Tandlængde	mm	820	820	820	820	820	820	820	820	820
Antal cylinder		2	2	2	3	3	2	2	3	3
Cylinder størrelse	mm	90/40	100/50	110/50	110/5 (x2) 90/40 (x1)	100/50	100/50	110/50	110/5 (x2) 90/40 (x1)	100/50
Volume	m ³	0.8	0.95	1.1	1.25	1.4	0.95	1.1	1.25	1.4
Vægt	kg	476	528	609	751	790	507	595	720	759
PRIS: Uden kroge og slanger		30 800	34 100	37 400	52 300	56 800	34 100	37 400	52 300	56 800
Krogsæt		A = 1 700 B = 3 000				A = 1 700 B = 3 000				
Coverplade for ryggen	1	1 000	1 400	1 500	1 700	1 900	1 400	1 500	1 700	1 900
Slanger, frontlæssere		700				700				
Trykbegrænserventil		2 100				2 100				
Lastholde / trykbegrænserventil		2 400				2 400				
Tandtype		F – Smedede tænder				P – Profilskårne tænder				



Udsiftbar påboltet parkeringsstøtte. Smart design og indbygget i overfaldet så det let skærer igennem ensilagen.



Varenummer på krogsæt finder du på side 40







Tilbehør:

Coverplade



Trykbegrænserventil



SILOCUT L+		175 F	200 F	225 F	250 F	175 P	200 P	225 P	250 P	175 B	200 B	225 B	250 B		
  126 cm	Bredde	mm	175	200	225	250	175	200	225	250	175	200	225	250	
	Total højde åben	cm	184	184	184	184	184	184	184	184	178	178	178	178	
	Max åbningshøjde	cm	126	126	126	126	126	126	126	126	126	126	126	126	
	Dybde	cm	83	83	83	83	83	83	83	83	83	83	83	83	
	Antal tænder		14	16	18	20	14	16	18	20	-	-	-	-	
	Tandlængde	mm	820	820	820	820	820	820	820	820	-	-	-	-	
	Antal cylinder	mm	2	2	2	2	2	2	2	2	2	2	2	2	
	Cylinder størrelse	mm	110/50	125/60	125/60	125/60	110/50	125/60	125/60	125/60	110/50	125/60	125/60	125/60	
	Skærstål (BxT)	mm	-	-	-	-	-	-	-	-	150X18	150X18	150X18	150X18	
	Volume	m ³	1.4	1.6	1.8	2.0	1.4	1.6	1.8	2.0	1.4	1.6	1.8	2.0	
	Vægt	kg	928	967	1032	1105	916	955	1020	1093	908	1028	1148	1268	
	PRIS: Uden kroge og slanger			63 600	69 300	74 000	78 600	63 100	68 200	72 900	77 500	64 700	70 600	75 200	79 800
	Krogsæt			A = 1 700 B = 3 000				A = 1 700 B = 3 000				A = 1 700 B = 3 000			
	Hydraulisk afskubber	1	11 200	13 000	14 900	16 800	11 200	13 000	14 900	16 800	Findes ikke				
	Plast og net holder*	2	4 700				4 700				4 700				
	Coverplade for ryggen	3	1 300	1 600	1 600	1 600	1 300	1 600	1 600	1 600	Findes ikke				
Sekvensventil for afskubber		4 200				4 200				N/A					
Slangesæt for afskubber		700				700				N/A					
Sekvensventil for plast og net holder		4 200				4 200				4 200					
Slangesæt for plast og net holder		700				700				700					
Trykbegrænserventil		2 100				2 100				2 100					
Tandtype			F – Smedede tænder				P – Profilskårne tænder				B = Skovlversion				
 Over 230 bar Trykbegrænserventil nødvendig		 F				 P				 B					

Tillbehør:

(1) Hydraulisk afskubber



(2) Plast og net holder



(3) Coverplade



Sekvensventil

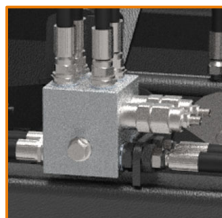

Plast og net holder



*4.funktion kræves hvis der ikke er sekvensventil monteret.

Varenummer på krogsæt
finder du på side 40

ENSILAGEREDSKAB

Quicke

SILOCUT XL+



		225 F	250 F
Bredde	cm	225	250
Total højde åben	cm	192	192
Max åbningshøjde	cm	125	125
Totalhøjde	cm	139	139
Dybde	cm	86	86
Antal tænder		15	17
Tandlængde	mm	985	985
Antal cylinder	mm	2	2
Cylinder størrelse	mm	125/60	125/60
Skærstål (BxT)	mm	-	-
Volume	m ³	2.4	2.8
Vægt	kg	1381	1498

PRIS: Uden kroge **84 200** **91 500**

Krogsæt 4 200

Afskubber 1 17 000 18 100

Plast og net holder* 2 4 700

Sekvensventil for afskubber	4 200
Slangesæt for afskubber	700
Sekvensventil for plast og net holder	4 200
Slangesæt for plast og net holder	700
Trykbegrænserventil	2 100



125/128 cm

Tillbehør:

(1) Afskubber



(2) Plast og net holder



Sekvensventil

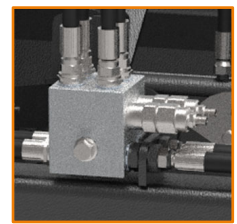

Plast og net holder



Over 230 bar
Trykbegrænserventil
nødvendig

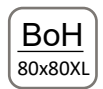

BoH
80x80XL

Tandtype **F – Smedede tænder**

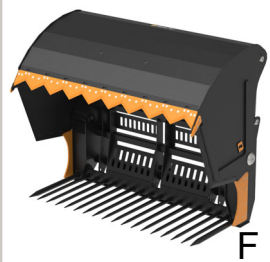

F

P – Profilskårne tænder



P

B = Skovlversion

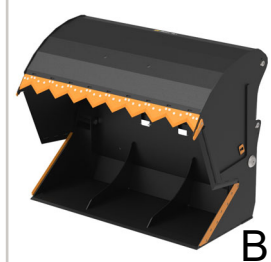

B



Silocut XL+ B



Silocut XL+ P

*4.funktion kræves hvis sekvensventil inte är installerad.

Varenummer på krogsæt
finder du på side 40

MULTIBENNE S+			90	100	120	140	160
Bredde	cm		90	100	120	140	160
Dybde	cm		86	86	86	86	86
Volume	m ³		0.38	0.43	0.52	0.62	0.71
Antal tænder			5	5	6	7	8
Vægt	kg		168	176	224	274	298
PRIS: Uden kroge			10 700	11 200	13 600	14 100	14 500
Krogsæt			1 700		A = 1 700 B = 2 600		
Gavlforøgere			800				
Skærstål 500 HB			1 900	2 100	2 400	2 700	3 000



BoH
M16 S/L



Over 190/210 bar
Trykbegrænserventil
nødvendig

Varenummer på krogsæt
finder du på side 40

MULTIBENNE M+			130	150	170	190	210	230	250
Bredde	cm		130	150	170	190	210	230	250
Dybde	cm		80	80	80	80	80	80	80
Volume	mm		7	8	9	10	11	12	13
Antal tænder	m ³		0.66	0.76	0.86	0.96	1.07	1.17	1.27
Vægt	kg		280	304	360	386	423	447	477
PRIS: Påsvejste kroge			21 500	23 000	24 300	25 300	27 200	28 800	30 300
PRIS: Uden kroge			20 600	22 100	23 400	24 400	26 300	27 900	29 400
Krogsæt			2 600						
Gavlforøgere			Lige = 2 900 / Konveks = 3 100						



Euro

BoH
M16 L

Tilbehør:

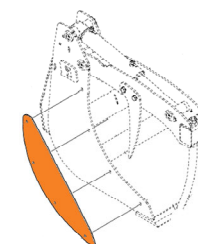

Lige

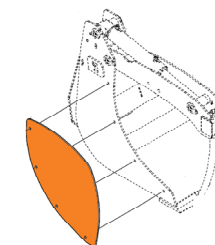

Konveks

MULTIBENNE XL			190	210	230	250
Bredde	cm		190	210	230	250
Dybde	cm		94.5	94.5	116.5	116.5
Højde	cm		65	65	80	80
Volume, fyldt og lukket	m ³		1.0	1.16	1.74	1.85
Vægt	kg		615	670	881	932
Skærstål (BxT)	mm		190X20	190X20	250X25	250X25
PRIS: Uden kroge			30 800	33 200	38 500	39 600
Krogsæt			3 000			
Skærstål			Leveres som standard med ekstra skær påboltet			
Gavlforøgere			1 600	1 600	1 600	1 600
Spildkant			1 800			

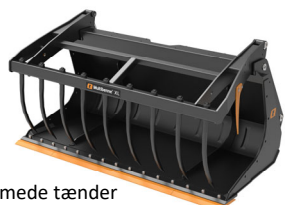

Smede tænder

Redskabet leveres uden spildkant
og gavlførøgere.



Over 250 bar
Trykbegrænserventil
nødvendig

BoH
Rail L

Montering af
krogsæt: 150 kr netto



SILOGRAB S+			90	110	130	150
Bredde	cm		95	115	135	155
Dybde	cm		87.5	87.5	87.5	87.5
Højde, åben	cm		127	127	127	127
Volume	m ³		0.43	0.52	0.62	0.71
Antal tænder	stk		5+5	6+6	7+7	8+8
Vægt	kg		165	213	245	277
PRIS: Uden kroge			10 700	12 700	13 800	14 900
Krogsæt			1 700		A = 1 700 B = 2 600	



BoH
M16 S/L

SILOGRAB M+			130	150	170	190	210	230	250	
Bredde	cm		130	150	170	190	210	230	250	
Dybde	cm		85	85	85	85	85	85	85	
Volume	m ³		0.69	0.79	0.90	1.01	1.11	1.22	1.33	
Antal tænder	mm		7+7	8+8	9+9	10+10	11+11	12+12	13+13	
Vægt	kg		250	270	300	320	355	377	405	
PRIS: Påsvejste krog			20 400	21 600	22 500	22 900	23 800	24 500	28 700	
PRIS: Uden kroge			19 500	20 700	21 600	22 000	22 900	23 600	27 800	
Krogsæt									2 600	
Trykbegrænserventil									2 100	
Lastholde / trykbegrænserventil									2 400	



Euro

over 210 bar
Trykbegrænserventil
nødvendig

BoH
M16 L

SILOGRAB XL			190	210	230	250	
Bredde	cm		190	210	230	250	
Dybde	cm		120	120	140	140	
Volume	m ³		1.0	1.1	1.7	1.9	
Højde, lukket	cm		104	104	190	190	
Højde, åben	cm		185	185	190	190	
Antal tænder	stk		10	11	12	13	
Vægt, F-version	kg		560	600	750	800	
Vægt, P-version	kg		619	667	851	900	
PRIS: F – version uden kroge			39 100	40 200	45 900	47 300	
PRIS: P – version uden kroge			35 900	37 400	42 900	44 500	
Krogsæt							3 000
Coverplade							2 100
Spildkant							1 800



F = Smedede tænder
P = Profilskårne tænder

over 250 bar
Trykbegrænserventil
nødvendig

BoH
Rail L



Montering af
krogsæt: 150 kr netto

Varenummer på krogsæt
finder du på side 40

MULTIGRAB CS & C



		CS 120	C 120	C 140	C 170
Bredde	cm	124	124	139	172
Dybde	cm	51.6	59.8	59.8	59.8
Højde	cm	64	74	74	74
Volume	m ³	0.22	0.3	0.34	0.42
Vægt	kg	90	133	141	161
PRIS: Påsvejste krog		9 700	11 500	12 200	13 000
Gavlforøger		300		400	
Gribeskinne, savtakket		400		500	

Euro
Skid
steer

Tilbehør:

Gavlforøger



Gribeskinne, savtakket

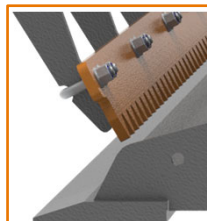

Gavlforøger + gribeskinne



MULTIGRAB M+



BoH
M16 L

Tilbehør:

		200	220	240	260	Åbning
Bredde	cm	200	220	240	260	1 620 mm
Dybde	cm	121	121	121	121	
Højde	cm	106	106	106	106	
Volume	m ³	1.30	1.45	1.60	1.75	
Vægt	kg	560	589	673	694	
PRIS: Uden kroge		31 700	33 100	36 300	37 300	
Krogsæt		2 600				
Gavlforøgere	1	1 000				
Klemmeskinne	2	2 400		3 200		
Gribeskinne, savtakket	3	2 100		3 000		
Tandbeskytter	4	700		900		
Cylinderbeskytter (påboltet)	5	1 100				
Skærstål 500 HB		4 300	4 700	5 100	5 300	
Trykbegrænserventil		2 100				
Lastholde / trykbegrænserventil		2 400 (kommer i 2024)				



NYHED

Op til 4.5
tons løfte-
kapacitet

Kan også bruges på
læsemaskiner med Z-
kinematik



Multigrab M+ er designet til brug på frontlæssere, mindre læsemaskiner og middelstørrelse teleskoplæssere. Multigrab M+ er ideel til håndtering af ensilage, gødning, bio-materiale og mange andre lignende ting.

(1) Gavlforøger

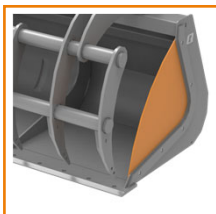

(2) Klemmeskinne



(3) Gribeskinne



(4) Tandbeskytter

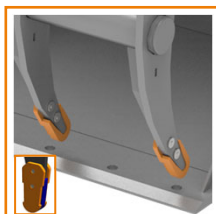

(5) Cylinderbeskytter



Trykbegrænserventil
/Lastholdeventil

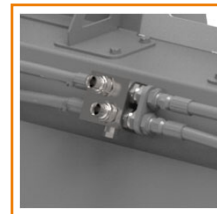

Varenummer på krogsæt
finder du på side 40

GØDNINGSGREB M+			130	150	170	190	230
	Bredde	cm	130	150	170	190	230
	Dybde	cm	85	85	85	85	85
	Antal tænder	stk	7	8	9	10	12
	Vægt	kg	123	136	152	165	203
PRIS: Påsvejste kroge			8 400	9 700	11 800	12 900	13 400
PRIS: Uden kroge			7 500	8 800	10 900	12 000	12 500
Krogsæt			2 600				



GØDNINGSGREB XL			190	210	230	250
	Bredde	cm	187	209	229	249
	Dybde	cm	85	85	111	111
	Antal tænder	stk	10	11	12	13
	Længde på tænder	mm	995	985	1240	1240
	Vægt	kg	324	353	458	488
PRIS: Uden kroge			21 200	22 600	25 900	28 800
Krogsæt			3 000			
Coverplade			2 100			
Spildkant			1 800			







Varenummer på krogsæt
finder du på side 40

HALMREDSKABER

Quicke

UNIGRIP™			130	160
 <p>Euro SMS</p>  <p>over 210 bar Trykbegrænserventil nødvendig</p> <p>BoH 40x80</p>	Ballestørrelse min. – max.	cm	90 – 130	120 – 160
	Vægt	kg	200	240
	PRIS: Påsvejste kroge***		15 800	17 400
	PRIS: Uden kroge		13 400	15 000
Krogsæt			A = 1 700 B = 3 000	
Slinger			700	
Trykbegrænserventil			1 800	
Lastholde / trykbegrænserventil			1 900	

FLEXIGRIP™			160	200
 <p>Euro SMS</p>  <p>over 210 bar Trykbegrænserventil nødvendig</p> <p>BoH 40x80</p>	Ballestørrelse min. – max.	cm	120 – 160	150 – 200
	Vægt	kg	262	287
	PRIS: Påsvejste kroge***		22 000	24 000
	PRIS: Uden kroge		19 600	21 600
Krogsæt			A = 1 700 B = 3 000	
Slinger			700	
Trykbegrænserventil			1 800	
Lastholde / trykbegrænserventil			1 900	

FLEXIBAL			89 MM RØRPROFIL	127 MM RØRPROFIL
 <p>Euro SMS</p>  <p>Over 210 bar Trykbegrænserventil nødvendig</p> <p>BoH 40x80</p>	Ballestørrelse	cm	180	180
	Vægt	kg	195	195
	PRIS:			
	PRIS: Påsvejste kroge***		22 900	22 900
PRIS: Uden kroge			20 500	20 500
Krogsæt			A = 1 700 B = 3 000	
Slinger			700	
Trykbegrænserventil			1 800	
Lastholde / trykbegrænserventil			1 900	

*** Version med påsvejste kroge leveres komplet med slanger som passer på Quicke frontlæssere.



Varenummer på krogsæt
finder du på side 40

QUADROGRIP TS			135 cm arme	160 cm arme
	Højde	cm	53,5	53,5
	Ballestørrelse, max.	cm	200	200
	Ballestørrelse, min.	cm	65	65
	Bredde lukket	cm	175	175
	Bredde max åben	cm	251	251
	Dybde	cm	180	205
	Vægt	cm	420	428
	Løftekapacitet	kg	1500	1500
PRIS: Uden kroge			30 500	31 600
Krogsæt			A = 1 700 B = 3 000	
Slanger			700	
Ballestøtte			2 200	
Trykbegrænserventil			2 100	
Lastholde / trykbegrænserventil			2 400	
Flødesventil			1 800	

Montering af krogsæt: 150 kr netto



Over 210 bar
Trykbegrænserventil nødvendig

BoH
80x80

TOPGRIP			120	
	Ballestørrelse	cm	54 - 103	
	Vægt	kg	195	
	PRIS: Påsvejste kroge***			22 200
	PRIS: Uden kroge			19 800
	Krogsæt			A = 1 700 B = 3 000
Slanger			700	
Trykbegrænserventil			1 800	
Lastholde / trykbegrænserventil			1 900	

Montering af krogsæt: 150 kr netto



Over 210 bar
Trykbegrænserventil nødvendig

BoH
80x80

*** Version med påsvejste kroge leveres komplet med slanger som passer på Quicke frontlæssere.



Varenummer på krogsæt finder du på side 40

STORBALLEGREB S+

115



BoH
40x80



Bredde	cm	115
Højde	cm	100
Løftekapacitet	kg	1 000
Antal tænder konus 2		Op til 3
Vægt	kg	98,5
PRIS: Påsvejste kroge uden tænder		3 900
PRIS: Uden kroge uden tænder		3 700
Krogsæt		A = 1 700 B = 3 000

Vælg tandsæt i tabellen til højre

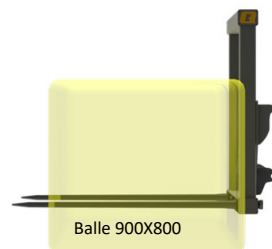

Balle 900X800

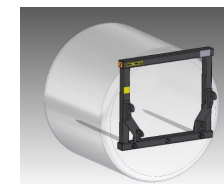

Montering af
krogsæt: 150 kr netto

STORBALLEGREB M

180



Euro



Bredde	cm	180
Højde	cm	140
Løftekapacitet	kg	2 000
Antal tænder konus 2		Op til 5
Vægt	kg	135
PRIS: Påsvejste kroge uden tænder		6 000

Vælg tandsæt i tabellen til højre

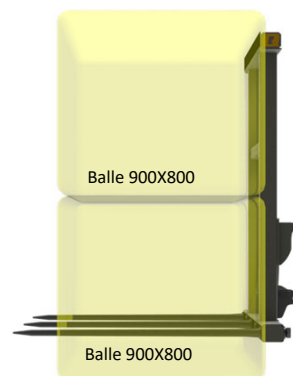

Balle 900X800

Balle 900X800



Tandsæt

Tandsæt 2 X 82 cm	1 600
Tandsæt 3 X 82 cm	2 400
Tandsæt 4 X 82 cm	3 200
Tandsæt 5 X 82 cm	4 000
Tandsæt 2 X 124 cm	1 700
Tandsæt 3 X 124 cm	2 550
Tandsæt 4 X 124 cm	3 400
Tandsæt 5 X 124 cm	4 250

STORBALLEGREB L

200



Euro /
3-punkt



Bredde	cm	200
Højde	cm	102
Løftekapacitet	kg	2500
Antal tænder konus 2		Op til 5
Vægt	kg	170
PRIS: Påsvejste kroge uden tænder		8 100

Vælg tandsæt i tabellen til højre

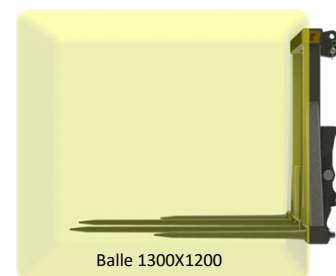

Balle 1300X1200

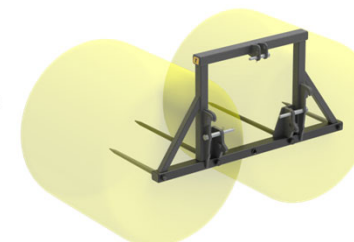

3-punkt Kategori 2 og 3N

STORBALLEGREB L+

FAST TANDBJÆLKE

150

BoH
80x80

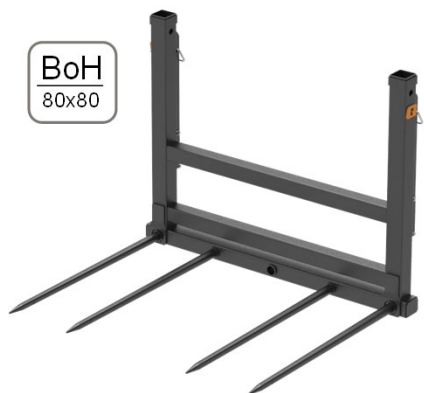

Bredde	cm	152,5
Højde	cm	116,5
Max højde med overbygning	cm	176 / 184
Max last	kg	2 000
Antal tænder konus 2		Op til 5
Vægt	kg	98
PRIS: Uden kroge uden tænder		6 100
Krogsæt		A = 1 700 B = 3 000
Overbygning med tænder (1)		2 100
Topbjælke til overbygning (2)		1 100

Vælg tandsæt i tabellen til højre

Montering af krogsæt: 150 kr netto

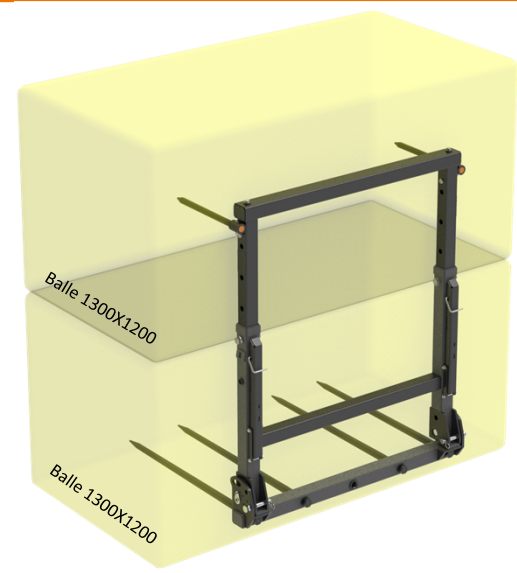
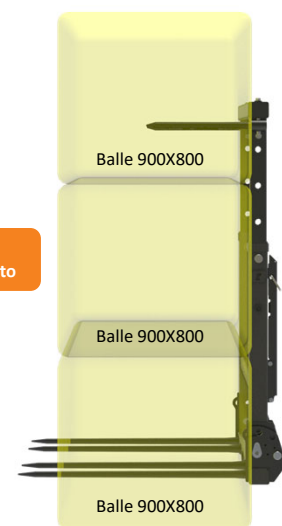

STORBALLEGREB L+

FOLDBAR TANDBJÆLKE

150

BoH
80x80



Bredde	cm	152,5
Højde	cm	116,5
Max højde med overbygning	cm	176 / 184
Løftekapacitet	kg	2000
Antal tænder konus 2		Op til 5
Vægt	kg	122
PRIS: Uden kroge uden tænder		7 500
Krogsæt		A = 1 700 B = 3 000
Overbygning med tænder (1)		2 100
Topbjælke til overbygning (2)		1 100
Hydraulisk foldbar tandbjælke (3)		4 700
Slanger for frontlæsser		700

Vælg tandsæt i tabellen til højre

Tilbehør:

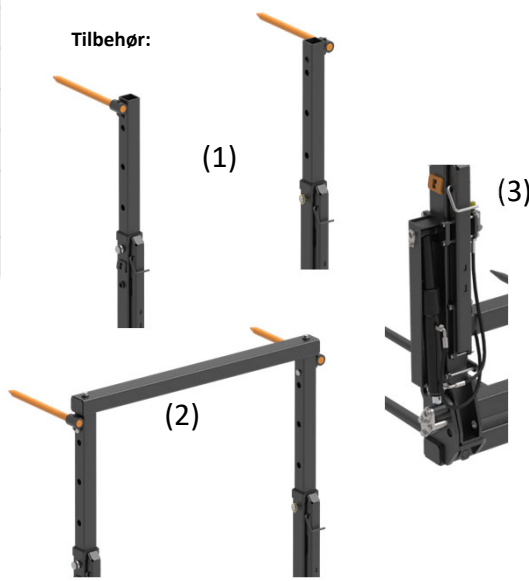

Montering af krogsæt: 150 kr netto

Tandsæt

Tandsæt 2 X 82 cm	1 600
Tandsæt 3 X 82 cm	2 400
Tandsæt 4 X 82 cm	3 200
Tandsæt 5 X 82 cm	4 000
Tandsæt 2 X 124 cm	1 700
Tandsæt 3 X 124 cm	2 550
Tandsæt 4 X 124 cm	3 400
Tandsæt 5 X 124 cm	4 250

- Storballegrab L + 150 foldbar tandbjælke i tre mulige positioner
1. Transportposition, tænderne er låst imod redskabsryggen.
 2. Arbejdsposition, tænderne kan flyde op og ned.
 3. Parkeringsposition, tænderne er låst vandret position.

STORBALLEGREB XL+

FOLDBAR TANDBJÆLKE

200

BoH
80x80



OBS: Alt tilbehør er monteret på dette redskab

Bredde	cm	200
Højde	cm	176
Max højde med overbygning	cm	187 / 295
Max last	kg	2 500
Antal tænder konus 2		Op til 5
Vægt	kg	157
PRIS: Uden kroge uden tænder		9 500
Krogsæt		A = 1 700 B = 3 000
Overbygning med tænder (1)		2 800
Topbjælke for overbygning (2)		1 100
Hydraulisk foldbar tandbjælke (3)		4 700
Slinger for frontlæsser		700
Hydraulisk overbygningsgreb (4)		8 600
Tandsæt overbygning (5)		600
Vælg tandsæt i tabellen til højre		

Tandsæt

Tandsæt 2 X 82 cm	1 600
Tandsæt 3 X 82 cm	2 400
Tandsæt 4 X 82 cm	3 200
Tandsæt 5 X 82 cm	4 000
Tandsæt 2 X 124 cm	1 700
Tandsæt 3 X 124 cm	2 550
Tandsæt 4 X 124 cm	3 400
Tandsæt 5 X 124 cm	4 250

Balle 900X800



Balle 1300X1200

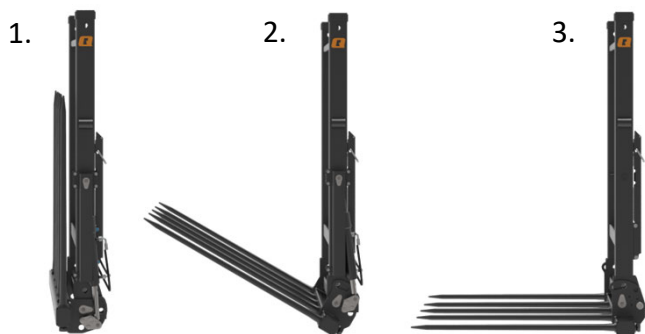

Storballegrab XL + 200 med foldbar tandbjælke i tre mulige positioner
 1. Transportposition, tænderne er låst mod redskabsryggen.
 2. Arbejdsposition, tænderne kan flyde op og ned.
 3. Parkeringsposition, tænderne er låst i vandret position

Tilbehør:

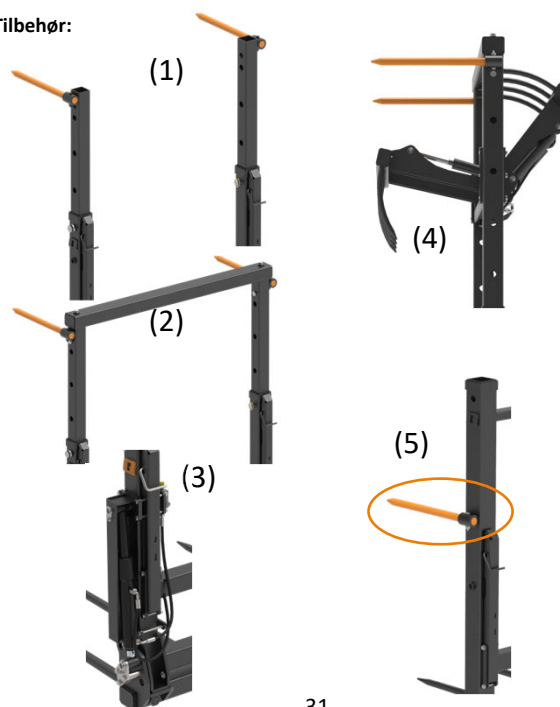

Med hydraulisk overbygningsgreb

Balle 900X800



Balle 900X800



BALLESPYD



Euro SMS

BoH 40x80

Bredde	cm	127
Tandlængde	cm	124
Vægt	kg	60
PRIS: Påboltet kroge		6 200
PRIS: Uden kroge		4 500
Krogsæt		A = 1 700 B = 3 000

SILOSPLIT



Euro SMS

BoH 40x80

Bredde	cm	120
Knivlængde	cm	170
Vægt	kg	110
PRIS:		
Påboltet kroge		14 500
Uden kroge		12 800
Krogsæt		A = 1 700 B = 3 000

STORBALLEGREB M 140



Euro

		140 2x82cm	140 2x124cm
Bredde	cm	140	140
Tandlængde	cm	82	124
Antal tænder	cm	2	2
Vægt	kg	78	88
PRIS: Påsvejste kroge		9 100	9 400
Overbygning		2 200	



Varenummer på krogsæt
finder du på side 40

PALLEGAFFEL C GAFFELRAMME BREDE 115 cm op til 800 kg



Bredde (typ FEM II)	cm	115,4	
PRIS GAFFELRAMME:		4 900	
Gaffelben (typ FEM II B)		800 kg	
Længde		800 mm	1060 mm
Dimension gaffelben	mm	80X32	80X32
Vægt	kg	53	63
PRIS GAFFELBENS PAR:		1 900	2 200

Mulige krogtyper:

- Euro
- Skid Steer
- Pin on (kun for Quicke C-Series læssere)

PALLEGAFFEL S GAFFELRAMME BREDE 100 cm op til 2 500 kg For kompakt/små hjullæssere



Bredde (typ FEM II)	cm	100				
PRIS GAFFELRAMME:		5 100				
Gaffelben (typ FEM II B)		1 000 kg		1 600 kg		2 500 kg
Længde		970 mm	1220 mm	970 mm	1220 mm	1220 mm
Dimension gaffelben	mm	80X32	80X32	80X40	80X40	100X40
Vægt	kg	62	72	74	86	107
PRIS GAFFELBENS PAR:		2 100	2 900	3 500	4 600	4 800
Tilbehør:						
Ballespyd**		3 600				

Mulige krogtyper:

- SMS**
- Avant *
- Euro** (Rambredde 120 cm)
- Giant
- Kramer Compact *
- Weidemann
- Schäffer Standard (SHW)
- Schäffer Hoftrack
- Zettelmeyer 402/Volvo L20.
- * Avant krog sæt kan ikke kombineres med 2500 kg pallegaffel.

Tilbehør:



** Kun på EURO og SMS ramme

PALLEGAFFEL M GAFFELRAMME BREDE 140 cm op til 2 500 kg



Bredde (type FEM II)	cm	140				
PRIS GAFFELRAMME:		5 600				
Gaffelben (type FEM II B)		1 000 kg		1 600 kg		2 500 kg
Længde		970 mm	1220 mm	970 mm	1220 mm	1220 mm
Dimension gaffelben	mm	80X32	80X32	80X40	80X40	100X40
Vægt	kg	62	72	74	86	107
PRIS GAFFELBENS PAR:		2 100	2 900	3 500	4 600	4 800
Tilbehør:						
Gribeklo		10 600				
Ballespyd		3 600				
Hydraulisk samle/sprede		14 500				

Mulige krogtyper:

- Euro
- SMS
- MX
- Skid Steer
- Ålö Type 3
- Alo Compact
- Weidemann
- Zettelmeyer 602/Volvo L30
- Zettelmeyer 402/Volvo L20
- Kramer Short
- Schäffer Standard (SHW)
- Dieci Small

Tilbehør:

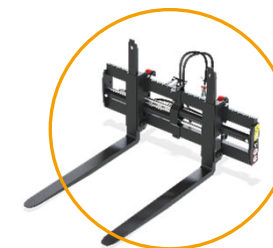
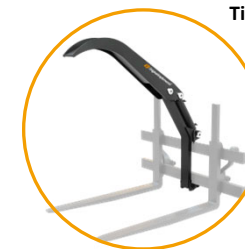

PALLEGAFFEL L 3500 kg + 5000 kg RAMMEBREDDE 120 cm og 150 cm

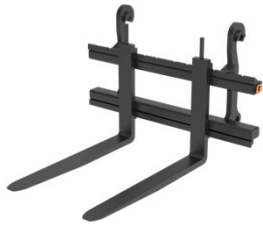

Bredde (type FEM III)	cm	120		150	
PRIS GAFFELRAMME:		7 300		7 900	
Gaffelben (type FEM III A*)		3 500 kg		5 000 kg	
Længde gaffelben		1220 mm	1500 mm	1220 mm	1500 mm
Dimension gaffelben	mm	125X45	125X45	150X50	150X50
ISO-standard gaffelben		3B	3A	3B	3B
Vægt	kg	158	184	198	228
PRIS GAFFELBENS PAR:		5 200	5 400	9 100	10 000
Tilbehør:					
Gaffelforlængere		< 2000mm 3 500	< 2500mm 3 800	< 2000mm 6 200	< 2500mm 6 400

Mulige krogtyper: Store BM

Bobcat / FDI / MF
Caterpillar CAT TH
Claas Scorpion
CNH LM
Dieci Medium
Dieci Large
Euro
JCB Q-Fit
JLG/Deutz Fahr
Kramer High
Manitou MLT
Matbro Pin and Cone,

Merlo ZM2
Merlo
Merlo ZM3 3PIN
Schäffer Standard
Schäffer HD (Type KR)
Weidemann
Weidemann 50-50
Zettelmeyer 602/Volvo L30

Tilbehør:



PALLEGAFFEL XL 8000 kg RAMMEBREDDE 200 cm

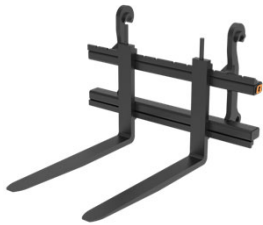

Bredde (type FEM IIII)	cm	200	
PRIS GAFFELRAMME:		11 700	
Gaffelben (type FEM IIII A*)		8 000 kg	
Længde gaffelben		1220 mm	1500 mm
Dimension gaffelben	mm	150X65	150X65
ISO-standard gaffelben		4A	4A
Vægt	kg	272	316
PRIS GAFFELBENS PAR:		15 300	16 600
Tilbehør:			
Gaffelforlængere		< 2000mm 6 900	< 2500mm 8 300

Mulige krogtyper:
Store BM
JCB Q-FIT
Claas Scorpion
Manitou MLT
Merlo ZM3 3Pin

Tilbehør:



STORSÆKKELØFTER			SINGEL	DUAL	TRIPEL
	Bredde	cm	127	213	278
	Højde min.	cm	164	170	170
	Højde max.	cm	164	221	221
	Kapacitet (pr. arm)	kg	1000	1500	1500
	Vægt	kg	79	177	269
PRIS: Påboltet kroge			8 500	14 600	20 000
PRIS: Uden kroge			6 800	11 600	17 000
Krogsæt			A = 1 700 B = 3 000		



BoH
40x80

BoH
80x80

Storsækkeløfter singel: 40x80
 Storsækkeløfter dual: 80x80
 Storsækkeløfter triple: 80x80

Euro
SMS
Type3
Store
BM

Montering af
krogsæt: 150 kr netto

3-PUNKTSRAMME			
	Vægt	kg	78
PRIS:			6 900

Euro
SMS



Varenummer på krogsæt
finder du på side 40



STENGREB M+			155	200	225
	Bredde	cm	156	200	222
	Dybde	cm	111	111	111
	Højde	cm	85	85	85
	Antal tænder		15	19	21
	Bredde, forreste tænder	mm	25	25	25
	Tanddiameter	mm	30	30	30
	Vægt	kg	242	318	348
	PRIS: Påsvejste kroge		15 000	17 000	20 000
	PRIS: Uden kroge		14 000	16 000	19 000
	Krogsæt		A = 1700B = 3000		
3-punktsophæng		3000			

Montering af krogsæt: 150 kr netto

Euro SMS

BoH
60x80

STENGREB XL+			230	255	280
	Bredde	cm	232	256	280
	Dybde	cm	160	160	160
	Højde	cm	81	81	81
	Antal tænder		20	22	24
	Bredde, forreste tænder	mm	35	35	35
	Tanddiameter	mm	40	40	40
	Vægt	kg	730	876	942
	PRIS: Påsvejste kroge		35 700	41 500	47 400
	PRIS: Uden kroge		31 800	37 600	43 500
	Krogsæt		4 200		
Stenoprækker, Store BM		2 300			
Stenoprækker, uden kroge		4 700			
3-punktsophæng, Store BM		3 000			
3-punktsophæng, uden kroge		4 200			

Store BM

BoH
80x80XL

Montering af krogsæt: 150 kr netto

Varenummer på krogsæt finder du på side 40

FRONTVÆGTE OG KONTRAVÆGT

Quicke

Q-BLOQ FRONTVÆGT		600	900	1800	600 ADD ON
	Vægt	600	900	1800	600
	Kategori	Kat. 2	Kat. 2	Kat. 3N	
PRIS:		14 800	21 600	44 600	13 300

Q-Bloq 600 kg ADD



Q-Bloq 600 kg



Q-Bloq 900 kg



Q-Bloq 1800 kg

ADAPTERE BOH 40X80		
	BOH 40X80 til Euro	7 500
	Kombiner med vores skrubbare kroge i 40X80-systemet.	Maksimal belastning: 3 000 kg

Reguleres af – DS/EN 12525:
Mindst 20% af traktor/frontlæsser bruttovægt inkl. modvægt, skal ligge på bagakslen.

MODVÆGT		800	1200
	Vægt, tom	186	212
	Vægt, fyldt	800	1200
PRIS:		10 200	10 600

Kontravægtene leveres tomme.

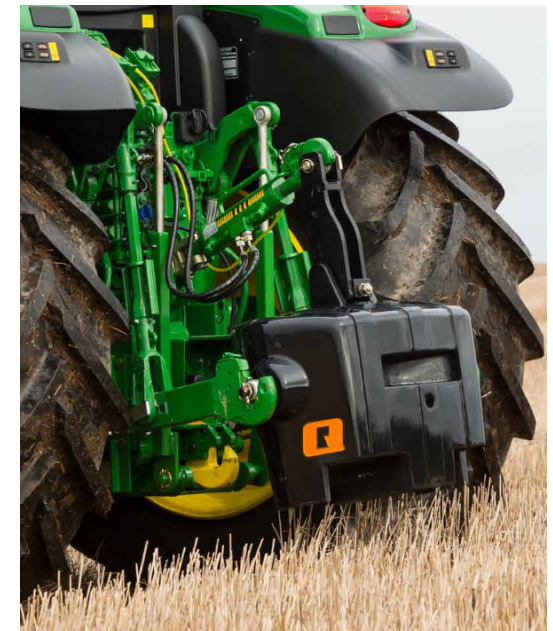

PÅBOLTELIGE KROGSÆT - OVERSIGT



REDSKAB	ANTAL	40x80	80x80	60x80	80x80 XL	RAIL S	RAIL L	M24	M16
Ballespyd MKII	1	X							
Flexibal	2	X							
Flexigrip	2	X							
Gødningsgreb XL	4						X		
Højtippende skovl	5	X							
Sneskovl	1								X
Multibenne S+, M+	12								X
Multibenne XL	8						X		
Powergrab S	4					X			
Powergrab XL	4						X		
Quadrogrip TS	1		X						
Silocut M+	10		X						
Silocut L+	12		X						
Silocut XL+	6				X				
Silograb S+. M+	11								X
Silosplit	1	X							
Skovl SXL+, SL+, GXL+, GL+, VXL+, VL+	23							X	
Skovl SM+, GM+, GS+	15								X
Storballegrab - Safety	2	X							
Storballegrab S+	1	X							
Storballegrab L+, XL+	3		X						
Stengreb M+*	3			X					
Stengreb XL	3				X				
Storsækkeløfter (1, 2 and 3 løftearme)**	3	X	X						
Topgrip	1		X						
Unigrip	2	X							

* 60x80 er samme krogkit som 40x80/80x80, men der bruges M16 bolte og laskeplader med gevindhuller i stedet for u-bøjler.

RAIL L:

M20 LANGE BOLTE

Gødningsgreb XL
Multibenne XL
Silograb XL

RAIL S:

M20 KORTE BOLTE

Powergrab S

40X80:

M16 - U-bøjle

Ballespyd MKII
Flexibal
Flexigrip
Højtippende skovl
Silosplit
Storballegrab – Safety
Storballegrab S+
Storsækkeløfter singel

80X80:

M16 - U-bøjle

Quadrogrip TS
Silocut M+
Silocut L+
Storsækkeløfter dual og triple
Storballegrab L+, XL+
Topgrip

80X80 XL:

M20 - U-bøjle

Stengreb XL+
Silocut XL+

M24:

Skovle SXL+, SL+, GXL+, GL+, VXL+, VL+
Powergrab L+, XL+

M16:

Skovle SM+, GM+, GS+
Multibenne S+, Multibenne M+
Silograb S+, Multibenne M+
Sneskovl



40x80/80x80



RAIL S/RAIL L



M24



80x80XL



M16 S
(op til 2 tons
løftekapacitet)



M16 L
(op til 3,7 tons
løftekapacitet)

VARENUMMER KROGSÆT

Krogssystem: 40X80 / 60X80 / 80X80	Varenr	Pris
Store BM	11254149X	3 000 kr
Euro	11254377X	1 700 kr
Euro -5° (Storballegrab L+, XL+)	11256057X	1 700 kr
SMS	11253940X	1 700 kr
TYP 3	11254509X	1 700 kr
A-ram / Triangel	11256216X	3 000 kr
Atlas 95	11256380X	3 800 kr
Atlas 65 Storballegrab, Storsækkeløfter dual & triple	11256499X	3 800 kr
Atlas 65 Silocut, Højtipskovl, Storsækkeløfter singel, Storballegrab L+	11256500X	3 800 kr
Atlas 35	11256501X	3 800 kr
Avant	11256182X	1 700 kr
Bobcat/FDI/MF	11255102X	3 000 kr
Caterpillar TH/AG2000	11255142X	3 000 kr
Claas Scorpion	11253575X	3 000 kr
CNH LM	11255100X	3 000 kr
Dieci Small	11255237X	3 000 kr
Dieci Medium	11255236X	3 000 kr
Dieci Large	11255242X	3 000 kr
Giant	11255328X	1 700 kr
Hauer	11255143X	1 700 kr
JCB Qfit	11253571X	3 000 kr
JCB TC	11254274X	3 000 kr
JCB TC Compact	11255141X	3 000 kr
JLG / Deutz Fahr	11255240X	3 000 kr
Kramer Compact	11256068X	3 000 kr
Kramer Short	11255368X	3 000 kr
Kramer High	11255415X	3 000 kr
Lille BM / Valtra	11255145X	1 700 kr
Manitou MLT	11253572X	3 000 kr
Matbro Pin & Cone	11253574X	3 000 kr
Merlo ZM2	11253573X	3 000 kr
Merlo ZM2S	11256460X	3 000 kr
Merlo ZM3 1 pin	11255137X	3 000 kr
Merlo ZM3 3 pin	11255138X	3 000 kr
M-X	11253971X	1 700 kr

Krogssystem: 40X80 / 60X80 / 80X80	Varenr	Pris
Schäffer Type KR	11255104X	3 000 kr
Schäffer HD Square	11255144X	1 700 kr
Schäffer Type SWH	11255232X	1 700 kr
Schäffer Square 336	11255636X	1 700 kr
Schäffer Square 442	11256269X	1 700 kr
Schäffer VM	11256163X	3 000 kr
Skidsteer	11254498X	1 700 kr
Weidemann	11255106X	1 700 kr
Weidemann MV	11256113X	1 700 kr
Weidemann 50-50	11256226X	1 700 kr
Zettelmeyer 402	11255139X	3 000 kr
Zettelmeyer 602	11255429X	3 000 kr
Zettelmeyer 602 (JCB)	11255498X	3 000 kr
Zettelmeyer 602 (Højtipskovl)	11255500X	3 000 kr
Zettelmeyer 602 (Claas)	11256253X	3 000 kr
Zettelmeyer 602 -26° (Claas)	11256254X	3 000 kr

Erstat X i varenr med:
 Q til 40X80-kroger
 B til 60X80-kroger (Stengreb M+)
 A til 80X80-kroger

VARENUMMER KROGSÆT



Krogssystem: 80X80 XL	Varenr	Pris	Krogssystem: RAIL L	Varenr	Pris	Krogssystem: RAIL S	Varenr	Pris
Stora BM	11255111Q	4 200 kr	Stora BM	11254147A	3 000 kr	Stora BM	11254147Q	3 000 kr
Stora BM (ekstra undergraving)	11255463Q	4 200 kr	Euro	11254088A	3 000 kr	Euro 18°	11254088Q	3 000 kr
Euro	11255324Q	4 200 kr	SMS	11254223A	3 000 kr	SMS 27°	11254099Q	3 000 kr
Bobcat/FDI/MF	11255221Q	4 200 kr	Lilla BM / Valtra	11254374A	3 000 kr	Lilla BM / Valtra	11254374Q	3 000 kr
Claas Scorpion	11255187Q	4 200 kr	Bobcat/FDI/MF	11254112A	3 000 kr	Bobcat/FDI/MF	11254112Q	3 000 kr
Dieci Large	11255224Q	4 200 kr	Caterpillar AG2000	11255184A	3 000 kr	Claas Scorpion	11254123Q	3 000 kr
JCB Qfit	11255188Q	4 200 kr	Claas Scorpion	11254123A	3 000 kr	CNH LM	11255512Q	3 000 kr
Manitou MLT	11255189Q	4 200 kr	CNH LM	11255512A	3 000 kr	Dieci Small	11255238Q	3 000 kr
Matbro Pin & Cone	11255220Q	4 200 kr	Dieci Small	11255238A	3 000 kr	Dieci Medium	11255234Q	3 000 kr
Merlo ZM2	11255567Q	4 200 kr	Dieci Medium	11255234A	3 000 kr	Dieci Large	11255098Q	3 000 kr
Merlo ZM3 1 pin	11255191Q	4 200 kr	Dieci Large	11255098A	3 000 kr	Hauer	11254366Q	3 000 kr
Merlo ZM3 3 pin	11255190Q	4 200 kr	Hauer	11254366A	3 000 kr	JCB Qfit	11254125Q	3 000 kr
Schäffer Type KR	11255323Q	4 200 kr	JCB Qfit	11254125A	3 000 kr	JCB TC Compact	11255492Q	3 000 kr
Schäffer VM	11256218Q	4 200 kr	JCB TC Compact	11255492A	3 000 kr	JLG / Deutz Fahr	11255241Q	3 000 kr
Weidemann 50-50	11255322Q	4 200 kr	JLG / Deutz Fahr	11255241A	3 000 kr	Kramer Short	11255294Q	3 000 kr
Zettelmeyer 602	11255490Q	4 200 kr	Kramer Short	11255294A	3 000 kr	Kramer High	11255431Q	3 000 kr
Zettelmeyer 602 (for JCB)	11255491Q	4 200 kr	Kramer High	11255431A	3 000 kr	Manitou MLT 4,4°	11254124Q	3 000 kr
3-punkt feste	11255325Q	4 200 kr	Manitou MLT	11255273A	3 000 kr	Manitou MLT 21°	11255273Q	3 000 kr
			Matbro Pin & Cone	11254621A	3 000 kr	Matbro Pin & Cone 14°	11254621Q	3 000 kr
			Merlo ZM2	11255569A	3 000 kr	Merlo ZM2	11255569Q	3 000 kr
			Merlo ZM3 1 pin	11255096A	3 000 kr	Merlo ZM3 1 pin	11255096Q	3 000 kr
			Merlo ZM3 3 pin	11255095A	3 000 kr	Merlo ZM3 3 pin	11255095Q	3 000 kr
			M-X	11254800A	3 000 kr	M-X	11254800Q	3 000 kr
			Schäffer Type KR	11255823A	3 000 kr	Schäffer Type KR	11255823Q	3 000 kr
			Schäffer HD Square	11254568A	3 000 kr	Schäffer HD Square	11254568Q	3 000 kr
			Schäffer Type SWH	11255233A	3 000 kr	Schäffer Type SWH	11255233Q	3 000 kr
			Skidsteer	11254368A	3 000 kr	Skidsteer	11254368Q	3 000 kr
			Terex Agrilift	11255249A	3 000 kr	Terex Agrilift	11255249Q	3 000 kr
			Weidemann	11254087A	3 000 kr	Weidemann 28°	11254087Q	3 000 kr
			Zettelmeyer 402	11254086A	3 000 kr	Weidemann 5° (Powergrab)	11254827Q	3 000 kr
			Zettelmeyer 602	11254085A	3 000 kr	Zettelmeyer 402	11254086Q	3 000 kr
			Zettelmeyer 602 (for JCB)	11255510A	3 000 kr	Zettelmeyer 602	11254085Q	3 000 kr
			Zettelmeyer 602 (Claas)	11256239A	3 000 kr	Zettelmeyer 602 (for JCB)	11255510Q	3 000 kr
						Zettelmeyer 602 (Claas)	11256239Q	3 000 kr

VARENUMMER KROGSÆT

Krogssystem: M24	Varenr	Pris	Krogssystem: M16S	Varenr	Pris	Krogssystem: M16L	Varenr	Pris
Store BM	11255310Q	4 200 kr	Euro	11255560Q	1 700 kr	Stora BM	11255615Q	2 600 kr
Store BM (ekstra undergravning)	11255430Q	4 200 kr	SMS	11255579Q	1 700 kr	Euro	11255559Q	2 600 kr
Stora BM (ekstra oppbrytningsvinkel)	11255354Q	4 200 kr	Avant	11255578Q	1 700 kr	SMS	11255590Q	2 600 kr
Euro	11255468Q	4 200 kr	Giant	11255589Q	1 700 kr	Typ 3	11255624Q	2 600 kr
SMS	11255124Q	4 200 kr	Kramer Compact	11255572Q	1 700 kr	A-ramme / Triangel	11256217Q	2 600 kr
Atlas 65	11256506Q	4 200 kr	Schäffer Square 336	11255591Q	1 700 kr	Atlas 65 Skovl med grep	11256505Q	2 600 kr
Atlas 95	11256356Q	4 200 kr	Schäffer Square 442	11256213Q	1 700 kr	Atlas 65 Skovl	11255658Q	2 600 kr
Atlas 95 (redskab med grep)	11256601Q	4 200 kr	Schäffer Type SWH	11255561Q	1 700 kr	Atlas 35 Skovl, Powergrab M+	11256502Q	2 600 kr
Bobcat/FDI/MF	11255307Q	4 200 kr	Weidemann	11255562Q	1 700 kr	Atlas 35 Silograb S+, Multibenne S+	11256503Q	2 600 kr
Caterpillar AG2000	11255269Q	4 200 kr	Weidemann MV	11256027Q	1 700 kr	Atlas	11255658Q	2 600 kr
Claas Scorpion -5°	11255309Q	4 200 kr				Bobcat/FDI/MF	11255632Q	2 600 kr
Claas Scorpion 2°	11255663Q	4 200 kr				Caterpillar TH	11255577Q	2 600 kr
CNH LM	11255511Q	4 200 kr				Claas Scorpion	11255612Q	2 600 kr
Dieci Small	11255271Q	4 200 kr				CNH LM	11255607Q	2 600 kr
Dieci Medium	11255265Q	4 200 kr				Dieci Small	11255629Q	2 600 kr
Dieci Large	11255261Q	4 200 kr				Dieci Medium	11255628Q	2 600 kr
Hauer	11256291Q	4 200 kr				Giant	11255585Q	2 600 kr
JCB Qfit	11255311Q	4 200 kr				JCB Qfit	11255617Q	2 600 kr
JCB Qfit Double Hook	11256282Q	4 200 kr				JCB TC Compact	11255635Q	2 600 kr
JCB TC Compact	11255134Q	4 200 kr				Kramer Short	11255610Q	2 600 kr
Kramer Short	11255274Q	4 200 kr				Manitou MLT	11255623Q	2 600 kr
Kramer High	11255413Q	4 200 kr				Matbro Pin & Cone	11255630Q	2 600 kr
Manitou MLT	11255308Q	4 200 kr				Merlo ZM2	11255618Q	2 600 kr
Matbro Pin & Cone	11255306Q	4 200 kr				Merlo ZM2S	11255593Q	2 600 kr
Merlo ZM2	11255312Q	4 200 kr				Schäffer Type KR	11255593Q	2 600 kr
Merlo ZM3 1 pin	11255260Q	4 200 kr				Schäffer Type SWH	11255588Q	2 600 kr
Merlo ZM3 3 pin	11255259Q	4 200 kr				Skidsteer	11255620Q	2 600 kr
M-X	11255121Q	4 200 kr				Weidemann	11255586Q	2 600 kr
Schäffer Type KR	11255263Q	4 200 kr				Weidemann 50-50	11255587Q	2 600 kr
Schäffer VM	11256130Q	4 200 kr				Zettelmeyer 402	11255616Q	2 600 kr
Skidsteer	11255992Q	4 200 kr				Zettelmeyer 602	11255558Q	2 600 kr
Weidemann	11255264Q	4 200 kr				Zettelmeyer 602 JCB	11255621Q	2 600 kr
Weidemann 50-50	11256305Q	4 200 kr				Zettelmeyer 602 (Claas)	11256191Q	2 600 kr
Zettelmeyer 602	11255270Q	4 200 kr						
Zettelmeyer 602 (för JCB)	11255470Q	4 200 kr						
Zettelmeyer 602 +8°(Claas)	11256192Q	4 200 kr						
Zettelmeyer 602 (Claas)	11256252Q	4 200 kr						

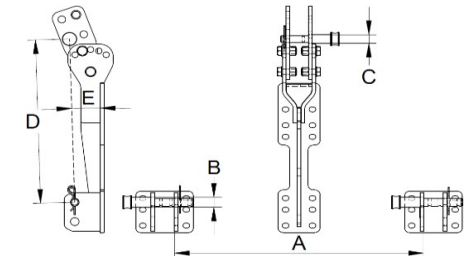

3-Point-Linkage (Category 2/2N/3)

Interface		A (Indvendig)	B (∅)	C (∅)	D (C-C)	Prisgruppe
Rail						
40x80/80x80	X	830/965 mm 32.7/38 in	25/31.5 mm 1/1.25 in	28/36.5 mm 1.1/1.44 in	610/685 mm 24/27 in	B
80x80 XL	X					
M24						
M16 S						
M16 L						

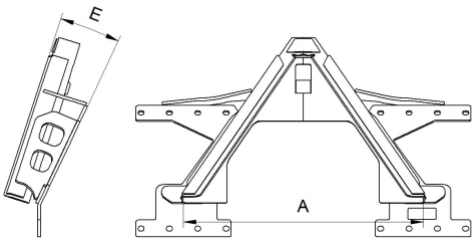

A-ram

Interface		A (Indvendig)	B (∅)	C (∅)	D (C-C)	Prisgruppe
Rail						
40x80/80x80	X	847 mm 33.3 in				B
80x80 XL						
M24						
M16 S						
M16 L	X					

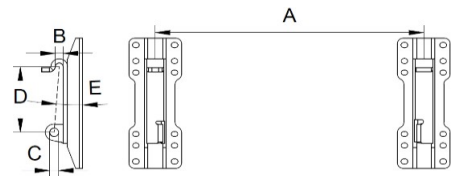

Ålö 3

Interface		A (Indvendig)	B (∅)	C (∅)	D (C-C)	Prisgruppe
Rail						
40x80/80x80	X	916 mm 36.06 in	27 mm 1.06 in	30.5 mm 1.20 in	237 mm 9.33 in	A
80x80 XL						
M24						
M16 S						
M16 L	X					

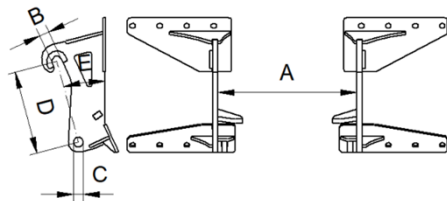

Atlas/Weycor 35

Interface		A (Indvendig)	B (∅)	C (∅)	D (C-C)	Prisgruppe
Rail						
40x80/80x80	X	514 mm 20.24 in	36 mm 1.42 in	36 mm 1.42 in	310 mm 12.20 in	B
80x80 XL						
M24						
M16 S						
M16 L	X					

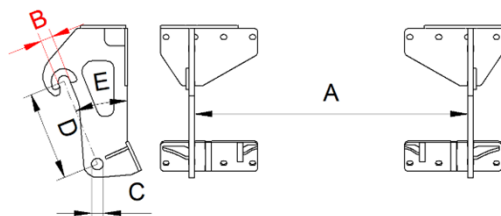

Atlas/Weycor 65

Interface		A (Indvendig)	B (∅)	C (∅)	D (C-C)	Prisgruppe
Rail						
40x80/80x80	X	946 mm 37.24 in	41 mm 1.61 in	41 mm 1.61 in	310 mm 12.20 in	B
80x80 XL						
M24	X					
M16 S	X					
M16 L						

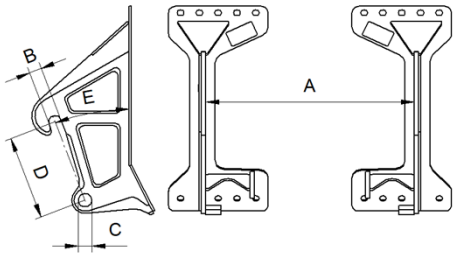

Atlas/Weycor 95

Interface		A (Inner)	B (∅)	C (∅)	D (C-C)	PRISGRUPPE
Rail						B
40x80/80x80	X					
80x80 XL		946 mm	56 mm	61 mm	380 mm	
M24	X	37.24 in	2.2 in	2.4 in	12.26 in	
M16 S						
M16 L						

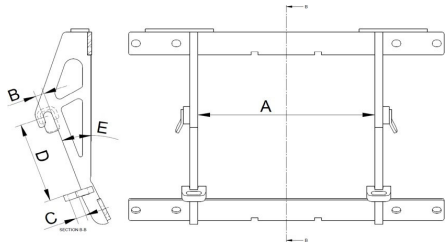

Avant

Interface		A (Inner)	B (∅)	C (∅)	D (C-C)	PRISGRUPPE
Rail						B
40x80/80x80	X					
80x80 XL		438 mm	22 mm	25 mm	211 mm	
M24		17.24 in	0.87 in	0.98 in	8.31 in	
M16 S	X					
M16 L						

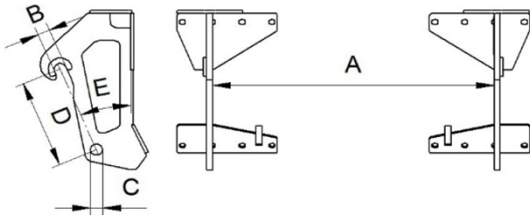

Bobcat / FDI / Massey Ferguson (MF)

Interface		A (Inner)	B (∅)	C (∅)	D (C-C)	PRISGRUPPE
Rail	X					B
40x80/80x80	X					
80x80 XL	X	765 mm	80 mm	38.25 mm	568.5 mm	
M24	X	30.12 in	3.15 in	1.51 in	2.24 in	
M16 S						
M16 L	X					

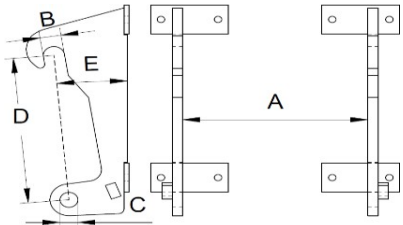

Caterpillar Telehandler

Interface		A (Inner)	B (∅)	C (∅)	D (C-C)	PRISGRUPPE
Rail	X	540 mm 21.26 in	62 mm 2.44 in	52 mm 2.05 in	505 mm 19.88 in	B
40x80/80x80	X					
80x80 XL						
M24	X					
M16 S						
M16 L	X					

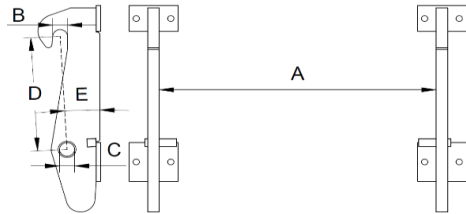

Claas Scorpion

Interface		A (Inner)	B (∅)	C (∅)	D (C-C)	PRISGRUPPE
Rail	X	960 mm 37.80 in	51 mm 2.01 in	52 mm 2.05 in	434.5 mm 17.11 in	B
40x80/80x80	X					
80x80 XL	X					
M24	X					
M16 S						
M16 L	X					

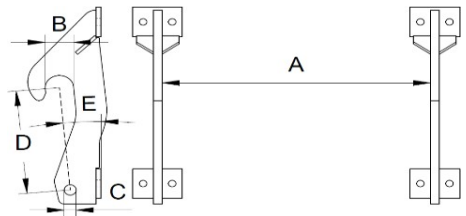

Case New Holland, CNH LM

Interface		A (Inner)	B (∅)	C (∅)	D (C-C)	PRISGRUPPE
Rail	X	765 mm 30.1 in	83 mm 3.27 in	35 mm 13.78 in	349.5 mm 1.38 in	B
40x80/80x80	X					
80x80 XL						
M24	X					
M16 S						
M16 L	X					

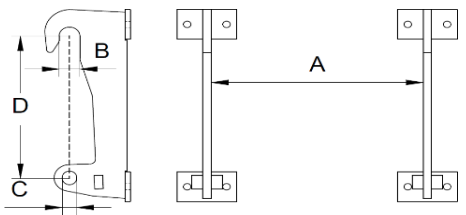

Dieci Small *

Interface		A (Inner)	B (∅)	C (∅)	D (C-C)	PRISGRUPPE
Rail	X	620 mm 24.41 in	61 mm 2.40 in	42 mm 1.65 in	482.4 mm 18.99 in	B
40x80/80x80	X					
80x80 XL						
M24	X					
M16 S						
M16 L	X					

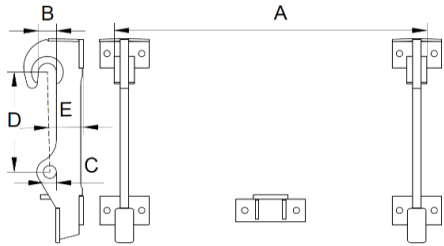

Dieci Medium *

Interface		A (indvendig)	B (∅)	C (∅)	D (C-C)	Prisgruppe
Rail	X	1080 mm 42.52 in	62 mm 2.44 in	44 mm 1.73 in	350 mm 13.78 in	B
40x80/80x80	X					
80x80 XL						
M24	X					
M16 S						
M16 L	X					

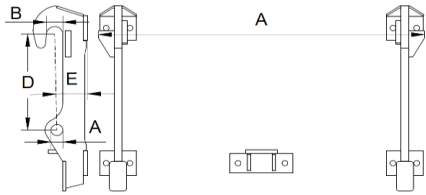

Dieci Large *

Interface		A (indvendig)	B (∅)	C (∅)	D (C-C)	Prisgruppe
Rail	X	1240 mm 48.82 in	62 mm 2.44 in	44 mm 1.73 in	390 mm 15.35 in	B
40x80/80x80	X					
80x80 XL	X					
M24	X					
M16 S						
M16 L						

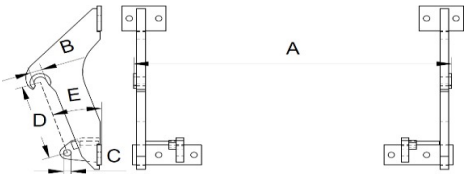

Euro

Interface		A (indvendig)	B (∅)	C (∅)	D (C-C)	Prisgruppe
Rail	X	1080 mm 42.52 in	42 mm 1.65 in	26 mm 1.02 in	299 mm 11.77 in	A
40x80/80x80	X					
80x80 XL	X					
M24	X					
M16 S	X					
M16 L	X					

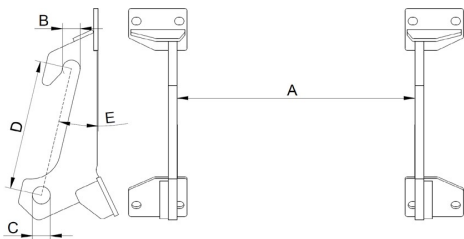

Giant

Interface		A (indvendig)	B (∅)	C (∅)	D (C-C)	Prisgruppe
Rail		555 mm 21.85 in	41 mm 1.61 in	41,5 mm 1.63 in	310,5 mm 12.22 in	B
40x80/80x80	X					
80x80 XL						
M24						
M16 S	X					
M16 L	X					

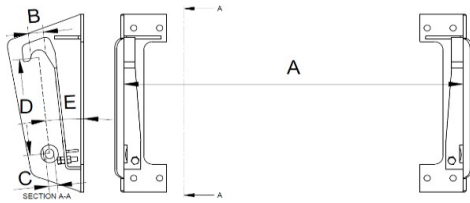

Hauer						
Interface		A (indvendig)	B (∅)	C (∅)	D (C-C)	Prisgruppe
Rail	X	1110 mm 43.70 in	55 mm 2.17 in	30 mm 1.18 in	355 mm 13.98 in	A
40x80/80x80	X					
80x80 XL						
M24						
M16 S						
M16 L						

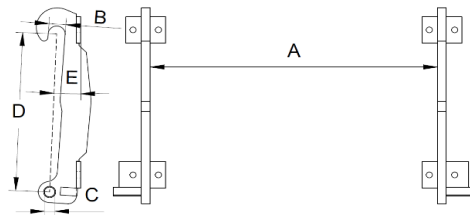

JCB Q-fit						
Interface		A (indvendig)	B (∅)	C (∅)	D (C-C)	Prisgruppe
Rail	X	997 mm 39.25 in	60 mm 2.36 in	37 mm 1.46 in	600 mm 23.62 in	B
40x80/80x80	X					
80x80 XL	X					
M24	X					
M16 S						
M16 L	X					

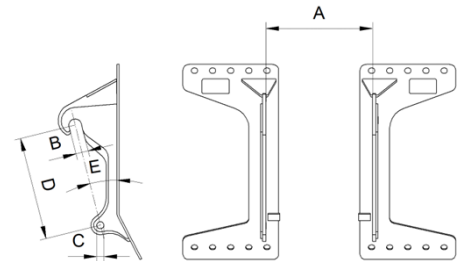

JCB TC						
Interface		A (indvendig)	B (∅)	C (∅)	D (C-C)	Prisgruppe
Rail	X	500 mm 19.70 in	59 mm 2.3 in	34 mm 1.3 in	490 mm 19.3 in	B
40x80/80x80	X					
80x80 XL						
M24	X					
M16 S						
M16 L	X					

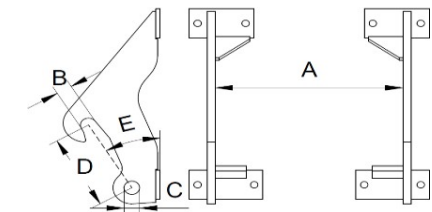

JCB TC Compact						
Interface		A (indvendig)	B (∅)	C (∅)	D (C-C)	Prisgruppe
Rail	X	546 mm 21.50 in	47 mm 1.85 in	45.5 mm 1.79 in	248.5 mm 9.78 in	B
40x80/80x80	X					
80x80 XL						
M24	X					
M16 S						
M16 L	X					

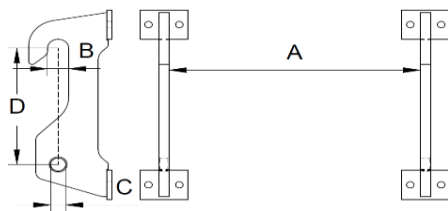

JLG / Deutz Fahr						
Interface		A (indvendig)	B (∅)	C (∅)	D (C-C)	Prisgruppe
Rail	X	734 mm 28.90 in	62 mm 2.44 in	44 mm 1.73 in	399 mm 15.71 in	B
40x80/80x80	X					
80x80 XL						
M24						
M16 S						
M16 L						

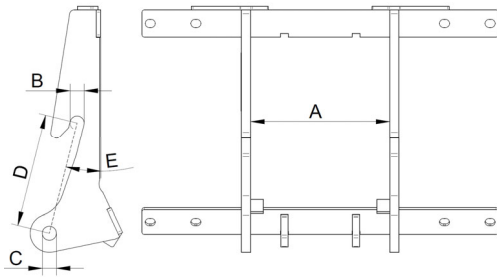

Kramer Compact

Interface		A (indvendig)	B (∅)	C (∅)	D (C-C)	Prisgruppe
Rail						B
40x80/80x80	X	305 mm 12 in	31 mm 1.22 in	31 mm 1.22 in	251,5 mm 9.9 in	
80x80 XL						
M24						
M16 S	X					
M16 L						

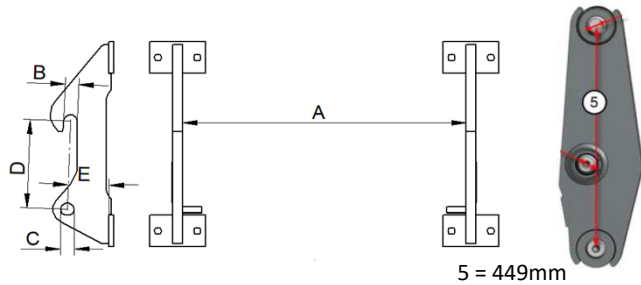

Kramer Short (mekanisk stop)

Interface		A (indvendig)	B (∅)	C (∅)	D (C-C)	Prisgruppe
Rail	X					B
40x80/80x80	X	865 mm 34.06 in	41 mm 1.6 in	41 mm 1.6 in	280 mm 11 in	
80x80 XL						
M24	X					
M16 S						
M16 L	X					

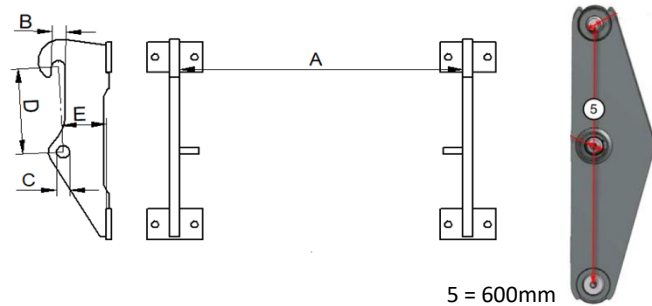

Kramer High (mekanisk stop)

Interface		A (indvendig)	B (∅)	C (∅)	D (C-C)	Prisgruppe
Rail	X					B
40x80/80x80	X	865 mm 34.06 in	41 mm 1.6 in	41 mm 1.6 in	280 mm 11 in	
80x80 XL						
M24	X					
M16 S						
M16 L	X					

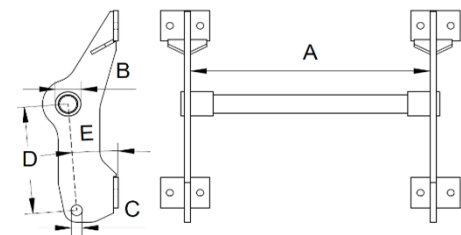

Manitou MLT

Interface		A (indvendig)	B (∅)	C (∅)	D (C-C)	Prisgruppe
Rail	X					B
40x80/80x80	X	750 mm 29.53 in	80 mm 3.15 in	35 mm 1.38 in	351 mm 13.82 in	
80x80 XL	X					
M24	X					
M16 S						
M16 L	X					

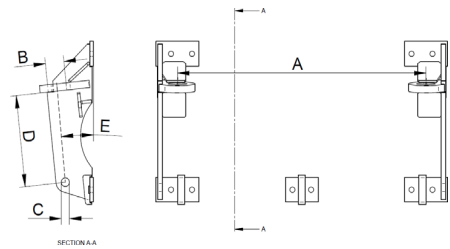

Pin and Cone (Matbro)

Interface		A (indvendig)	B (∅)	C (∅)	D (C-C)	Prisgruppe
Rail	X					B
40x80/80x80	X					
80x80 XL	X	1068 mm	80 mm	35 mm	370 mm	
M24	X	42.05 in	3.15 in	1.38 in	14.57 in	
M16 S						
M16 L	X					

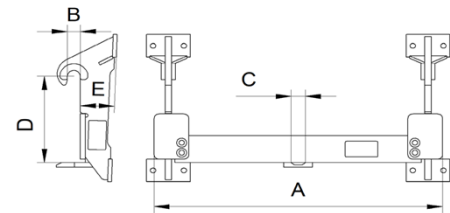

Merlo ZM2

Interface		A (indvendig)	B (∅)	C (∅)	D (C-C)	Prisgruppe
Rail	X					B
40x80/80x80	X					
80x80 XL	X	1126 mm	51 mm	35 mm	384,5 mm	
M24	X	44.33 in	2.0 in	1.38 in	15.14 in	
M16 S						
M16 L	X					

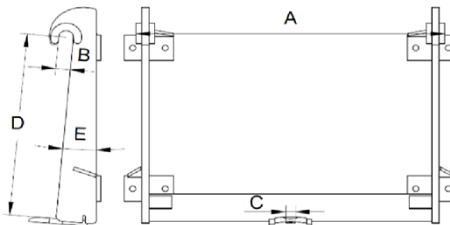

Merlo ZM3 1-pin

Interface		A (indvendig)	B (∅)	C (∅)	D (C-C)	Prisgruppe
Rail	X					B
40x80/80x80	X					
80x80 XL	X	1090 mm	52 mm	35 mm	709 mm	
M24	X	42.91 in	2.05 in	1.38 in	27.91 in	
M16 S						
M16 L						

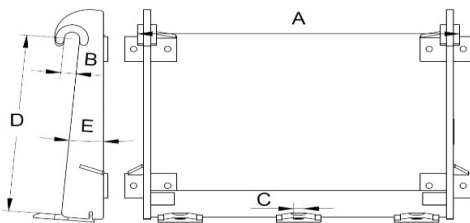

Merlo ZM3 3-pin

Interface		A (indvendig)	B (∅)	C (∅)	D (C-C)	Prisgruppe
Rail	X					B
40x80/80x80	X					
80x80 XL	X	1090 mm	52 mm	35 mm	709 mm	
M24	X	42.91 in	2.05 in	1.38 in	27.91 in	
M16 S						
M16 L						

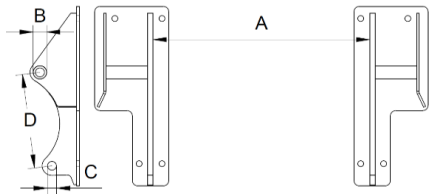

MX

Interface		A (indvendig)	B (∅)	C (∅)	D (C-C)	Prisgruppe
Rail	X	805 mm 31.69 in	50 mm 1.97 in	33 mm 1.30 in	256.8 mm 10.11 in	A
40x80/80x80	X					
80x80 XL						
M24	X					
M16 S						
M16 L						

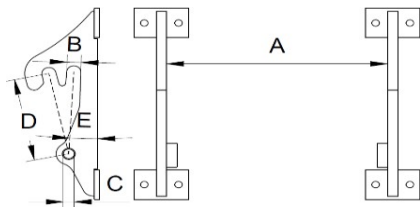

Schäffer Type SWH

Interface		A (indvendig)	B (∅)	C (∅)	D (C-C)	Prisgruppe
Rail	X	645 mm 25.39 in	41 mm 1.61 in	32 mm 1.26 in	279.5 mm 11.00 in	A
40x80/80x80	X					
80x80 XL						
M24						
M16 S	X					
M16 L	X					

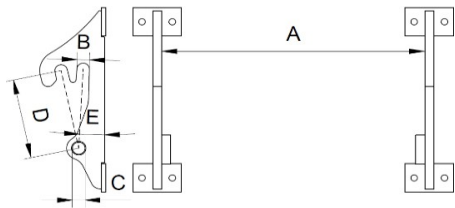

Schäffer Type KR

Interface		A (indvendig)	B (∅)	C (∅)	D (C-C)	Prisgruppe
Rail	X	867 mm 34.13 in	41 mm 1.61 in	42 mm 1.65 in	279.5 mm 11.00 in	B
40x80/80x80	X					
80x80 XL	X					
M24	X					
M16 S						
M16 L	X					

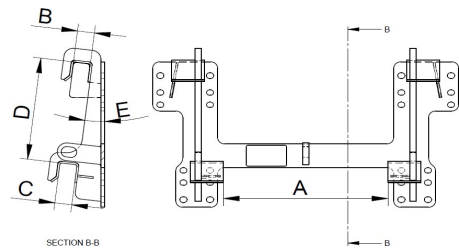

Schäffer Square 336

Interface		A (indvendig)	B (∅)	C (∅)	D (C-C)	Prisgruppe
Rail		520 mm 20.47 in	54 mm 1.13 in	54 mm 1.13 in	345 mm 13.58 in	A
40x80/80x80	X					
80x80 XL						
M24						
M16 S	X					
M16 L						

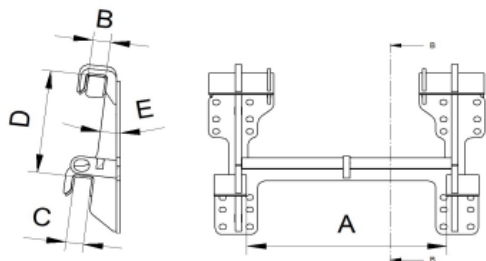

Schäffer Square 442

Interface		A (indvendig)	B (∅)	C (∅)	D (C-C)	Prisgruppe
Rail		620 mm 24.40 in	54 mm 1.13 in	54 mm 1.13 in	345 mm 13.58 in	A
40x80/80x80	X					
80x80 XL						
M24						
M16 S	X					
M16 L						

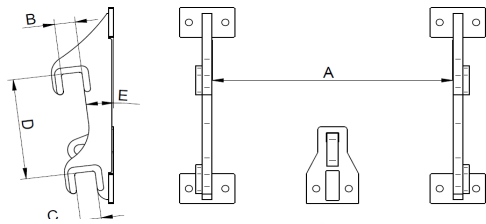

Schäffer HD Square

Interface		A (indvendig)	B (∅)	C (∅)	D (C-C)	Prisgruppe
Rail	X	740 mm 29.13 in	64 mm 2.52 in	64 mm 2.52 in	330 mm 12.99 in	A
40x80/80x80	X					
80x80 XL						
M24						
M16 S						
M16 L						

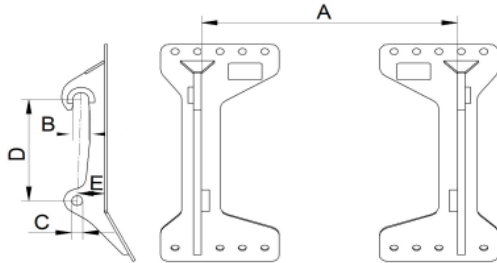

Schäffer VM

Interface		A (indvendig)	B (∅)	C (∅)	D (C-C)	Prisgruppe
Rail		970 mm 38.2 in	61 mm 2.4 in	42 mm 1.65 in	435 mm 17.10 in	A
40x80/80x80	X					
80x80 XL	X					
M24	X					
M16 S						
M16 L						

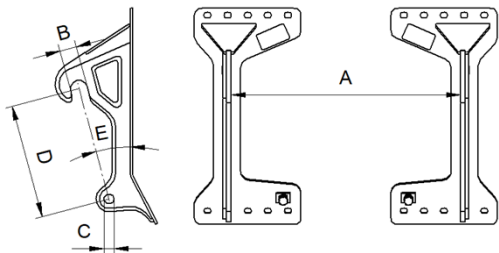

Sennebogen / Fendt

Interface		A (indvendig)	B (∅)	C (∅)	D (C-C)	Prisgruppe
Rail		970 mm 38.2 in	71 mm 2.8 in	41 mm 1.6 in	490 mm 19.3 in	A
40x80/80x80	X					
80x80 XL						
M24	X					
M16 S						
M16 L						

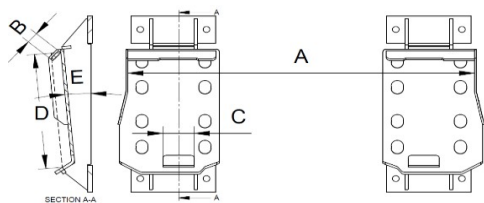

Skid-Steer

Interface		A (indvendig)	B (∅)	C (∅)	D (C-C)	Prisgruppe
Rail	X	1132 mm 44.57 in	40 mm 1.57 in	102 mm 4.02 in	422 mm 16.61 in	A
40x80/80x80	X					
80x80 XL						
M24						
M16 S						
M16 L	X					

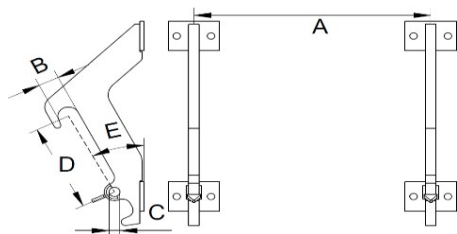

SMS

Interface		A (indvendig)	B (∅)	C (∅)	D (C-C)	Prisgruppe
Rail	X	690 mm 27.17 in	62 mm 2.44 in	32 mm 1.26 in	292 mm 11.50 in	A
40x80/80x80	X					
80x80 XL						
M24	X					
M16 S	X					
M16 L	X					

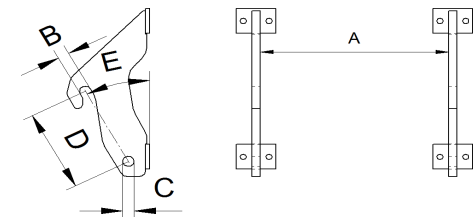
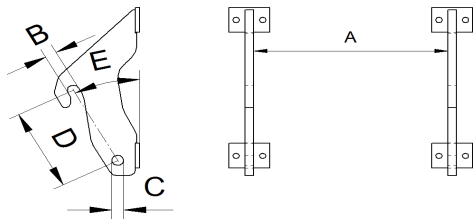
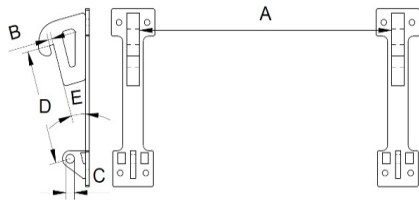
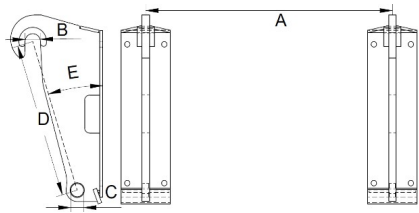

Volvo BM Large

Interface		A (indvendig)	B (∅)	C (∅)	D (C-C)	Prisgruppe
Rail	X					
40x80/80x80	X	1000 mm 39.37 in	62 mm 2.44 in	52.4 mm 2.06 in	616 mm 24.25 in	B
80x80 XL	X					
M24	X					
M16 S						
M16 L	X					

Volvo BM Small / Valtra

Interface		A (indvendig)	B (∅)	C (∅)	D (C-C)	Prisgruppe
Rail	X					
40x80/80x80	X	985 mm 38.78 in	16 mm 0.63 in	33 mm 1.30 in	420 mm 16.53 in	A
80x80 XL						
M24						
M16 S						
M16 L						

Weidemann

Interface		A (indvendig)	B (∅)	C (∅)	D (C-C)	Prisgruppe
Rail	X					
40x80/80x80	X	660 mm 25.98 in	36 mm 1.41 in	321.5 mm 12.66 in		A
80x80 XL						
M24	X					
M16 S	X					
M16 L	X					

Weidemann 50-50

Interface		A (indvendig)	B (∅)	C (∅)	D (C-C)	Prisgruppe
Rail	X					
40x80/80x80		845 mm 33.27 in	50.5 mm 1.99 in	51 mm 2.01 in	322 mm 12.68 in	A
80x80 XL	X					
M24						
M16 S						
M16 L	X					

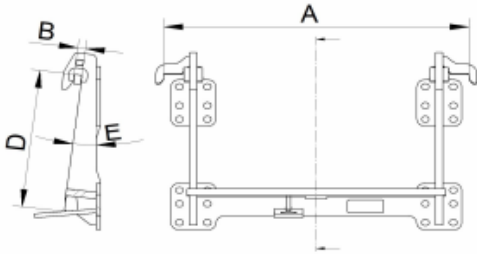

Weidemann MV

Interface		A (Indvendig)	B (∅)	C (∅)	D (C-C)	Prisgruppe
Rail						A
40x80/80x80	X	852 mm 33.5 in	50,5 mm 1.99 in		424 mm 16.68 in	
80x80 XL						
M24						
M16 S	X					
M16 L						

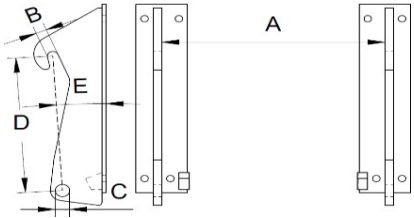

Zettelmeyer 402 / Volvo L20, L25

Interface		A (indvendig)	B (∅)	C (∅)	D (C-C)	Prisgruppe
Rail	X					B
40x80/80x80	X	650 mm 25.59 in	32 mm 1.26 in	42 mm 1.65 in	464 mm 18.27 in	
80x80 XL						
M24						
M16 S						
M16 L	X					

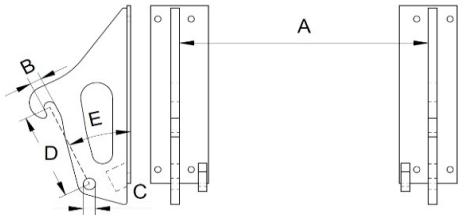

Zettelmeyer 602 / Volvo L30, L35

Interface		A (indvendig)	B (∅)	C (∅)	D (C-C)	Prisgruppe
Rail	X					B
40x80/80x80	X	862 mm 33.9 in	41 mm 1.61 in	42 mm 1.65 in	311.5 mm 12.26 in	
80x80 XL	X					
M24	X					
M16 S						
M16 L	X					

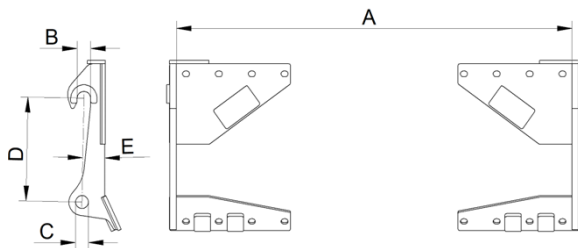

Ålö HD

Interface		A (indvendig)	B (∅)	C (∅)	D (C-C)	Prisgruppe
Rail						B
40x80/80x80		1203 mm 47.36 in	41 mm 1.61 in	39 mm 1.53 in	309 mm 12.2 in	
80x80 XL						
M24	X					
M16 S						
M16 L	X					

Quicke

Member of JOST World